



Haiwell PLC

Products Catalogue

- Easy to Study and Use •

XIAMEN HAIWELL TECHNOLOGY CO., LTD.

www.haiwell.com



Haiwell PLC includes **Classic-type** black PLC and **Card-type** white PLC (A series PLC). It is a versatile high-performance programmable logic controller, which is widely used in plastics, packaging, textiles, food, medical, pharmaceutical, environmental, municipal, printing, building materials, elevators, central air conditioning, numerical control machine tools and other fields of systems and control equipment. In addition to its own various peripheral interfaces (digital input, digital output, analog input, analog output, high-speed counter, high-speed pulse output channels, power supply, communication ports, etc.), it is also expandable with all types of expansion modules for flexible configuration.

Haiwell company owns the full independent intellectual property rights over both its hardware and software products, all products can be customized according to customer's requirements to meet the different needs of various industries.

7 Characteristics

- ◆ **Quality Guarantee:** In accordance with IEC-61131 international standard develop
- ◆ **Radical innovation:** : Built-in simulator programming software, easy to study and easy to use
- ◆ **Remote control:** Support Haiwell Cloud platform, can use Haiwell Cloud to do remote programming for Haiwell PLC
- ◆ **Ethernet +:** Support Ethernet port and 5 other RS232/RS485 communication ports working simultaneously, support multilevel networking
- ◆ **Communication Function:** Support Modbus TCP, Haiwellbus TCP, Modbus RTU/ASCII, Haiwellbus high speed protocol, freedom protocol
- ◆ **Motion Control:** Support linear interpolation, ARC interpolation, original point return, backlash compensation, electric original point redefine
- ◆ **Distributed IO:** Expansion modules with Ethernet port and RS485 port, can be remote IO unit by distributed installation

CONTENTS

Haiwell Cloud Platform	4	Indicator Declare	34
Haiwell Products	4	CPU Indicator Declare	35
Haiwell PLC Features	5	Expansion Modules Indicator Declare	35
HaiwellHappy Programming Software	6	I/O Indicator Declare	36
Card-type PLC	8	I/O Wiring Diagram	37
PLC MPU List	9	Haiwell PLC Instruction Table	38
AC Series PLC MPU	9	SM System Status Bit	44
AT Series PLC MPU	9	SV System Register	48
AH Series PLC MPU	9	System Interruption Table	55
		Error Code Table	56
PLC Expansion List	10	Communication Address Code Table	59
Digital Expansion	10	Haiwell PLC Bit Component	59
Analog Expansion	10	Haiwell PLC Register Component	59
Humidity&Temperature Expansion	11	Declare:	59
Communication Expansion	11	 	
		Correspondence Address Setting	59
Classic PLC	12		
PLC MPU List	13		
C Series PLC MPU	13		
T Series PLC MPU	14		
H Series PLC MPU	15		
PLC Expansion List	16		
Digital Modules	16		
Analog Modules	17		
Temperature and Humidity Modules	17		
Weighing Modules	17		
Communication Modules	18		
Accessories	18		
Specification	18		
Haiwell PLC Specification	19		
Power Specification	20		
Product Environment Specification	21		
Digital Input (DI) Specification	22		
Digital Output (DO) Specification	22		
Analog Input (AI) Specification	22		
Analog Output (AO) Specification	24		
Analog Output (AO) Specification	24		
Analog Output (AO) Specification	24		
Expansion Modules Parameter	27		
4 Channels Analog Modules Parameter Table	27		
8 Channels Analog Modules Parameter Table	29		
Digital Modules Parameter Table	32		
Digital Temperature Module Parameter Table	34		

Haiwell Cloud Platform

Haiwell Cloud is a cross-platform IOT cloud platform. It supports PC, iPad, Android, IOS and other terminals. You can visit on-site equipment from a thousand miles away, and realize the remote monitoring and maintaining for HMI and PLC. It supports remote programming, firmware upgrades, monitoring and diagnosis etc.

Haiwell Cloud provides security mechanisms for communication. It is secured by the encryption mechanism of 128-bit SSL, which ensures the stable and safe data transfer. It also uses A-key and B-Key protection mechanism to enable secure remote access to the devices.

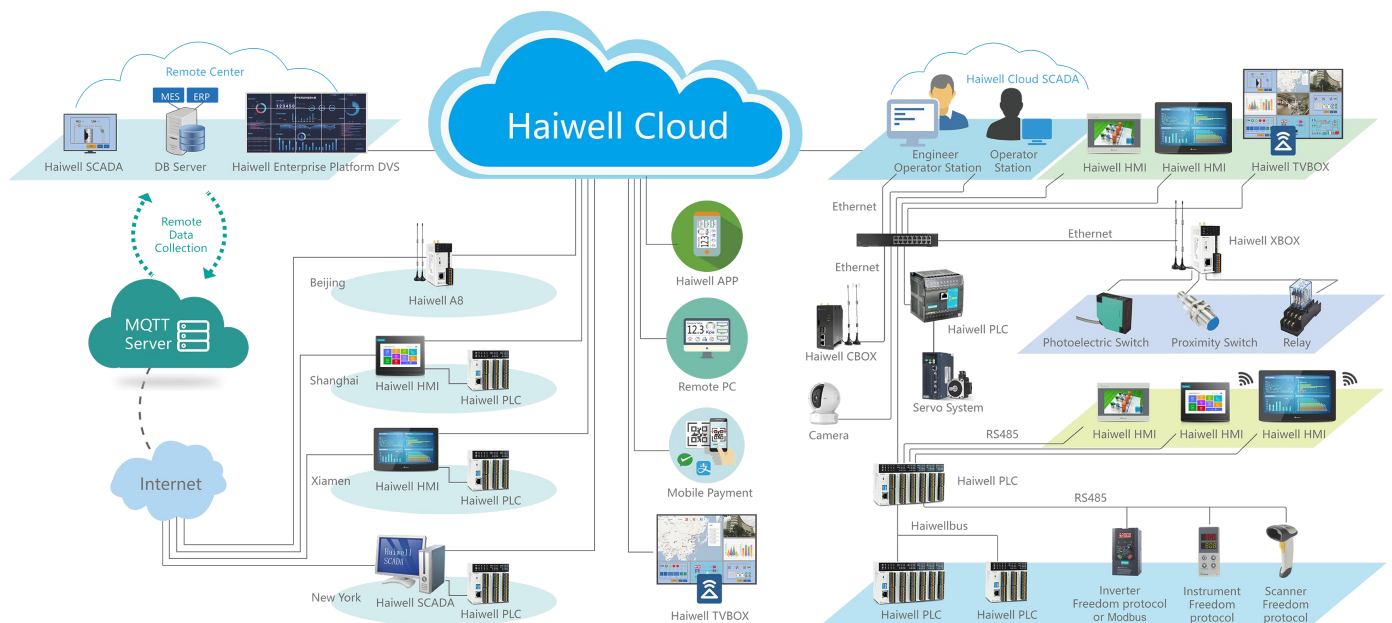

Haiwell Products

- PLC Controller
- IoT PLC
- IIoT Cloud HMI
- IIoT Cloud Box
- TVBOX
- Cloud SCADA
- Cloud APP
- Cloud Platform
- IIoT Enterprise Platform

Haiwell PLC Features

- **Ethernet + :** Host PLC and remote modules support Ethernet communication, host PLC support Ethernet port and 5 RS232/RS485 serial communication ports working simultaneously. Support multilevel networking, support remote programming, debugging, monitoring and data exchange. Easy to work with other PLC modules, HMI and PC via Ethernet port.
- **The firmware upgrade function:** Taking the lead in the function of realizing firmware upgrade in a small programmable controller. You can upgrade the system firmware through the firmware upgrade function for free, therefore the PLCs that you bought previously can also to have the latest features from Haiwell company.
- **Rich network communication function:** CPU host PLC supports built-in Ethernet port and 2 serial RS232/RS485 communication ports, it is expandable to 1 Ethernet port and 5 serial RS232/RS485 ports, each port can be programmed and connects to network, and all of them can be used as masters or slaves. It support multilevel networking and a variety of human-machine interface and configuration software. It can also connect to network with any third-party devices which have communication capabilities (such as inverters, instruments, barcode readers, etc.).
- **Supporting for multiple communication protocols:** Supports built-in Modbus TCP, Modbus RTU/ASCII protocol, free communication protocol and Haiwell Company's Haiwellbus TCP and Haiwellbus high-speed communication protocols. No matter which kind of communication protocols, it only needs a simple communication instruction when dealing with complex communication functions. You will no longer troubled by the problems as communications port's conflicts, sending&receiving control, communications interrupt handling issues and you can use a variety of protocols to exchange data easily by mixing them up in the program.
- **High-speed pulse counting function:** Supports 8-channels duplex high-speed (200KHz) pulse counting, and 7 kinds of counting mode (pulse / direction 1 octave, pulse / direction 2 octave, forward / reverse pulse 1 octave, forward / reverse pulse 2 octave, A / B phase pulse 1 octave, A / B phase pulse 2 octave, A / B phase pulse 4 octave), and three kinds of comparisons (single-stage comparison, the absolute mode comparison, the relative mode comparison), supports 48 segments comparison fixed value, with self-learning function.
- **High-speed pulse frequency measurement:** Supports 16-channel (200KHz) high-speed pulse frequency measurement, support the ways of time or pulses to measure the frequency.
- **High-speed pulse output:** Supports 8-channel duplex high-speed (200KHz) pulse output, support for acceleration and deceleration pulse output, multi-segment envelope pulse output function, a unique sync pulse output function makes it easy to achieve precise synchronization control. Stand-alone support 16-channel pulse width modulation (PWM), can drive 16 servo or stepper motors.
- **Motion control function:** Each model support for 8-channel (200KHz) motion control, supports arbitrary 2-channel linear interpolation, circular interpolation, support follower pulse output, absolute address, relative address, backlash compensation, original point return, definition of electrical origin.
- **PID control function:** support 32 channels increment PID, support 32 channels auto tuning PID and 32 channels fuzzy temperature control, work with TTC temperature curve control, VC valve control and other instructions to easily control complicated objects in the industry site.
- **Edge capture and interrupts:** CPU supports 8-channel up and down along the catch and interrupt functions, all digital inputs support signal filtering settings, all digital outputs remains set to support power output. Provide 52 real-time interrupts.
- **Powerful analog processing function:** AI register accesses the analog input directly, analog input support engineering conversion, sampling frequency settings, and zero correction. Available AQ registers control the analog output directly, analog output support engineering conversion and can be configured to maintain output.
- **Strong password protection function:** Three levels of password protection function (program files password, each block password, PLC hardware password) and prohibits the application to upload.
- **Self-diagnostic function, power failure protection function, calendar (RTC), floating point operations, etc.**

Haiwell PLC with 16 encoders

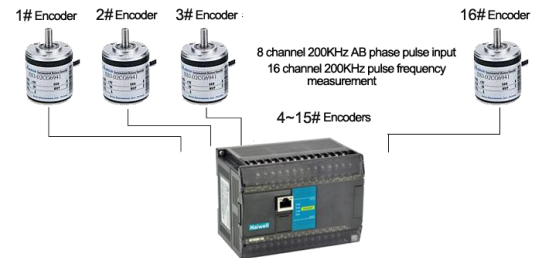

Haiwell PLC with 16 servos



HaiwellHappy Programming Software

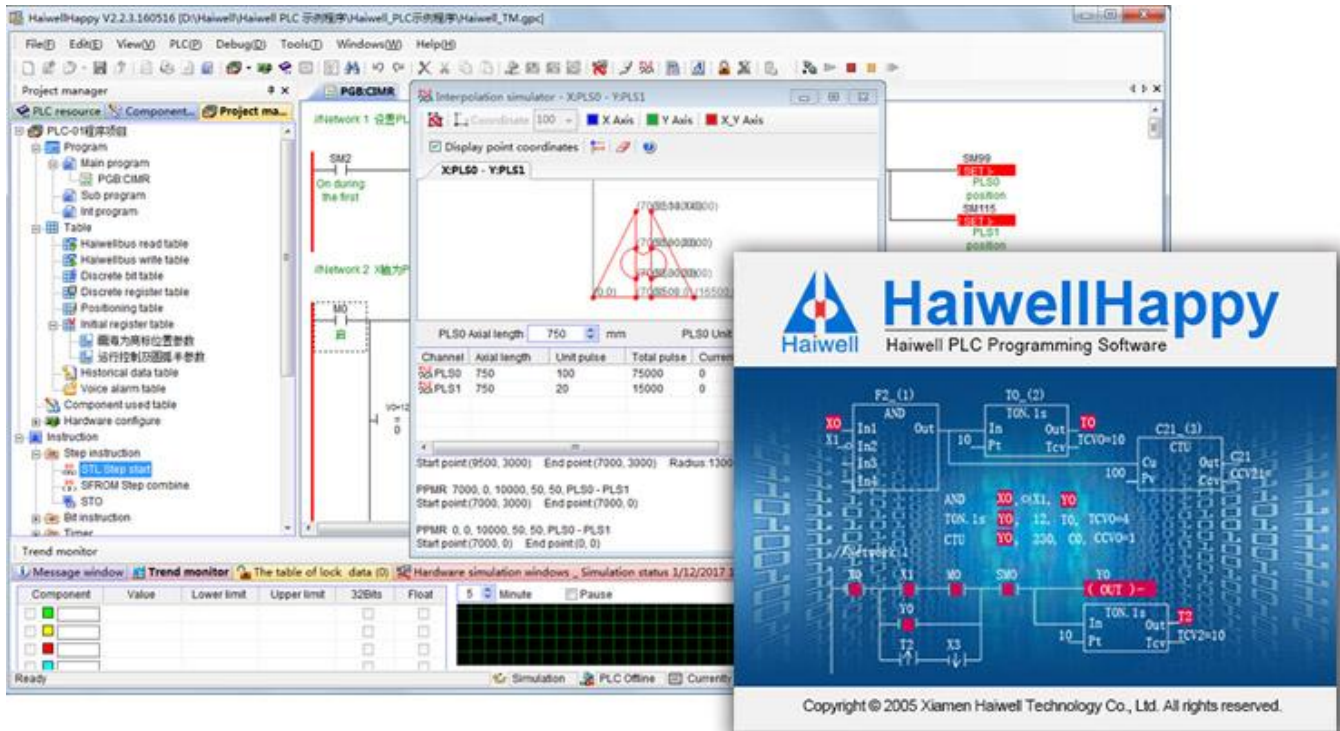

HaiwellHappy is a programming software which is in accordance with IEC 61131-3 standard. It can be used for Haiwell PLC programming. Furthermore, it supports built-in simulator and three kinds of programming languages (LD-Ladder Diagram, FBD-Function Block Diagram and IL-Instruction List). It can run on the systems of Windows 98, Windows 200X, Windows XP and the later Windows version.

Communications Simulator

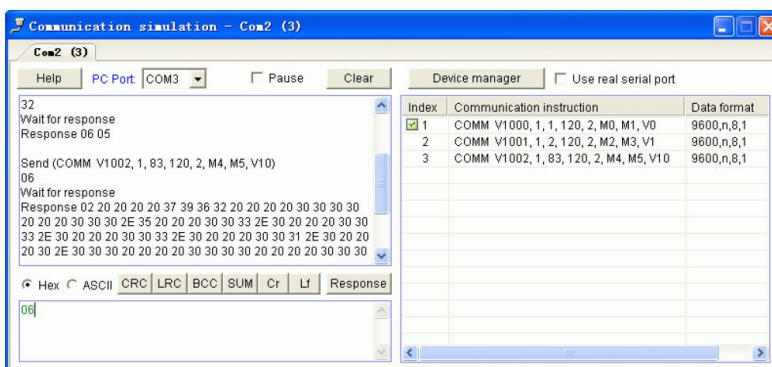

Interpolation Simulator

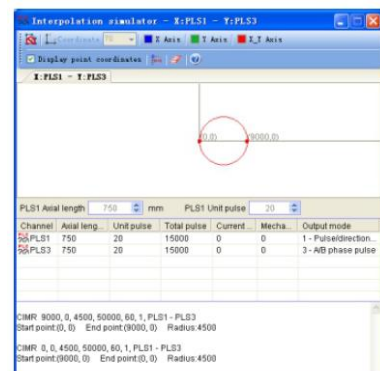

HaiwellHappy Features

- **Haiwell Cloud Programming:** Support Haiwell Cloud platform, can use Haiwell Cloud to do remote programming for Haiwell PLC as upload/download, firmware upgrading, self-diagnosis, monitoring and debugging. Easy for remote connection and real-time data monitoring of the site. Also you can do local programming through a HMI which supports built-in cloud engine.
- **Internal PLC simulator:** Haiwell PLC programming software is the first one with internal simulator in China, realizing the PLC program run in the simulation. During programming or the programming is completed, you can run PLC program in the simulation without online to check the program execution is correct or not. It can reduce on-site commissioning time greatly, reduce debugging difficult and improve debugging efficiency.
- **Communication simulator:** It is used to the debug communication instruction simulation tools. It can be manually input simulates response message returned from slave, or you can use the computer's serial port to communicate with slave really, Simulate the process that PLC executes communication instruction really and process the return data from the slave.
- **Interpolation simulator:** Track and draw the trajectory generated from motion control instructions such as the linear interpolation, circular interpolation, listing parameters of the pulse output channel of the motive plane and corresponding to each axis, display the current position of the channel, the mechanical home position, output mode, you can set shaft length, unit pulses.
- **PLC executable file generation:** PLC program can be generated to executable file which is released and executed independently. So you do not need to send the PLC program to the user, it can be very easy, very safe to put the PLC executable file to the user to download, but do not worry the user would can see the program content.
- **Facilitate innovation instruction set:** On the basis of analysis and absorption of various PLC instruction, Haiwell PLC launched many powerful innovations facilitate instruction. As communication instruction (COMM, MODR, MODW, HWRD, HWWR), data portfolio diversification instruction (BUNB, BUNW, WUNW, BDIB, WDIB, WDIW), PID control (PID), valve control (VC), upper and lower alarm (HAL, LAL), range transmitter (SC), temperature curve (TTC) etc. Any one instruction can realize the function but other PLC required to multiple instructions. These instructions are very easy to understand and use, greatly improve the programming efficiency and running speed.
- **Modular project structure:** Create 63 blocks total (main program, sub program, interrupt program) and chose any programming language to program. The execution order of block can be adjusted at random. Each block can be imported and exported independently and has the same password protected of program projects. So we can fully realize the modular programming and program reuse dreams.
- **Instruction using table:** Provides multiple instruction tables. Use these tables can reduce the amount of programs, saving program space, such as initialization data. Each table can be imported and exported independently and has the same password protection of program project.
- **Powerful online features:** Search out all the PLC that connect with the PC. Show running status, fault status, RUN / STOP switch position, hardware configuration information, communication port parameters such detailed information of all the online PLC. Select any PLC for online monitoring, program download, firmware upgrade, controlling PLC stop, adjusting PLC real-time clock, modifying password protection, modifying communication port parameters, modifying the watching-dog time and PLC station names.
- **Online monitoring and debugging functions:** Provide 10 pages of component's monitoring table. It can choose in decimal, hexadecimal, binary, floating point and character to display data. Support component and register component monitoring hybridly and displaying component annotation at the same time. All instruction tables can be imported to the monitoring table.
- **Unique real-time curve function:** Monitor any of the register elements of its real-time curve, convenient to control and debug during the process.
- **Humane input:** Provide shortcuts, drag and drop, click and many other command input. Suggest effective components or range of values for each input and output terminals. It can be entered directly. Some data of combination (such as communication protocols etc.) can also double-click the instruction to configure the input data.
- **Convenient annotation:** Provide the component comment, network comment, instruction comment, block comment, table comment, and project comment. After the component with "/" to input comments directly (e.g.: X0 // motor start). Comments can choose to download to the PLC for reading or modification facilitately.
- **Detailed tips and online help:** Provide PLC resource window, instruction window, etc. All the instructions and detailed description of hardware modules can be found in powerful online help system which is open through clicking F1 key in the programming interface to find the answer. Even if use HaiwellHappy programming software for the first time who can easily complete the preparation of control program.
- **Convenient editing functions:** Support all conventional editing operations, searching and replacing, instruction up and down, network up and down, copying and pasting between program projects.
- **Hardware configuration, sub program parameter passing, local components, indirection, print, preview, debugging, CRC calculation, password protection, etc.**

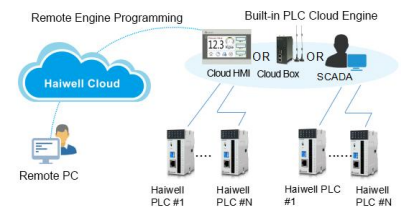

Remote Programming

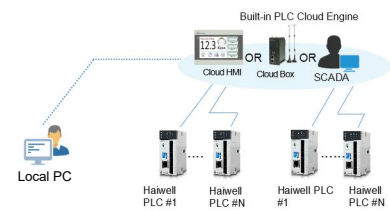

Local Programming

Card-type PLC

Ultra-thin design, humanized peripheral port design, saving installation space. Single Machine integrated digital & analog IO, small size, large application. Support Haiwell Cloud, remotely program and monitor the PLC through Haiwell Cloud. Single machine can expand up to 15 modules, maximum expansion I/O up to 256 points. Support Ethernet + RS485 + 3 RS232/RS485 communication ports to work at the same time, strong communication networking capabilities. Support linear interpolation, ARC interpolation, original point return, backlash compensation, electric original point redefine.

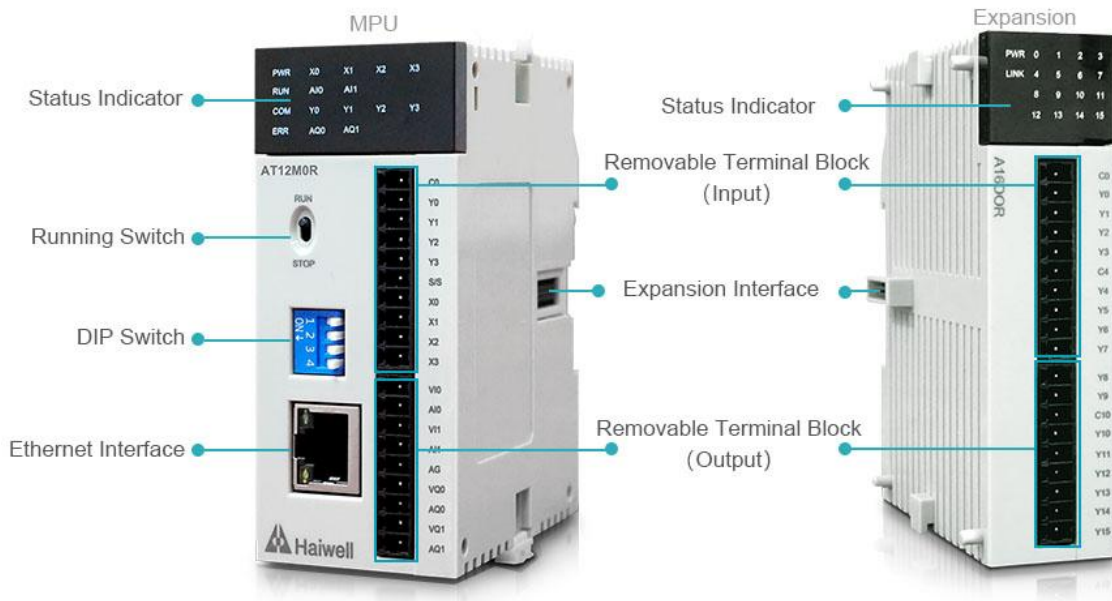

AC 10 S 0 R

1 2 3 4 5

- 1 Series**
AC series PLC MPU AT series PLC MPU AH series PLC MPU
- 2 I/O Point**
Built-in IO: 10-point, 12-point, 16-point are optional
- 3 Specification**
S: Standard Digital PLC MPU **M:** Digital+Analogy PLC MPU
- 4 Power Specification**
0: 24V DC
- 5 Output type**
R: Relay **T:** Transistor NPN **P:** Transistor PNP

PLC MPU List

AC Series PLC MPU

Model	Specification							Dimension WxHxD(mm)
24VDC	DI	DO	AI	AO	COM Port	Power	Exp.	
AC10S0R	6	4 Relay			TCP+485	<4.8W	3	 40×95×65
AC10S0T	6	4 Transistor NPN			TCP+485	<4.8W	3	
AC10S0P	6	4 Transistor PNP			TCP+485	<4.8W	3	
AC16S0R	8	8 Relay			TCP+485	<4.8W	3	
AC16S0T	8	8 Transistor NPN			TCP+485	<4.8W	3	
AC16S0P	8	8 Transistor PNP			TCP+485	<4.8W	3	
AC12M0R	4	4 Relay	2	2	TCP+485	<3.6W	3	
AC12M0T	4	4 Transistor NPN	2	2	TCP+485	<3.6W	3	
AC12M0P	4	4 Transistor PNP	2	2	TCP+485	<3.6W	3	

AT Series PLC MPU



Model	Specification									Dimension WxHxD(mm)
24VDC	DI	DO	AI	AO	Pulse Input	Pulse Output	COM Port	Power	Exp.	
AT16S0R	8	8 Relay			2 Channels A/B phase 4points 200K		TCP+485	<4.8W	15	 40×95×65
AT16S0T	8	8 Transistor NPN			2 Channels A/B phase 4points 200K	2 Channels A/B phase 4points 200K	TCP+485	<4.8W	15	
AT16S0P	8	8 Transistor PNP			2 Channels A/B phase 4points 200K	2 Channels A/B phase 4points 200K	TCP+485	<4.8W	15	
AT12M0R	4	4 Relay	2	2	1 Channel A/B phase 2points 200K		TCP+485	<3.6W	15	
AT12M0T	4	4 Transistor NPN	2	2	1 Channel A/B phase 2points 200K	1 Channel A/B phase 2points 200K	TCP+485	<3.6W	15	
AT12M0P	4	4 Transistor PNP	2	2	1 Channel A/B phase 2points 200K	1 Channel A/B phase 2points 200K	TCP+485	<3.6W	15	

AH Series PLC MPU

Model	Specification							Dimension WxHxD(mm)
24VDC	DI	DO	Pulse Input	Pulse Output	COM Port	Power.	Exp.	
AH16S0R	8	8Relay	4 Channels A/B phase 8points 200K		TCP+485	<4.8W	15	 40×95×65
AH16S0T	8	8 Transistor NPN	4 Channels A/B phase 8points 200K	4 Channels A/B phase 8points 200K	TCP+485	<4.8W	15	
AH16S0P	8	8 Transistor PNP	4 Channels A/B phase 8points 200K	4 Channels A/B phase 8points 200K	TCP+485	<4.8W	15	

PLC Expansion List

Digital Expansion

Model	Specification				Dimension WxHxD(mm)	
	24VDC	DI	DO	Power		COM Port
A08DI	8			<2.4W	/	 25×95×65
A08DOR			8 Relay	<4.8W	/	
A08DOT			8 Transistor NPN	<4.8W	/	
A08DOP			8 Transistor PNP	<4.8W	/	
A08XDR	4		4 Relay	<2.4W	/	
A08XDT	4		4 Transistor NPN	<2.4W	/	
A08XDP	4		4 Transistor PNP	<2.4W	/	
A16DI	16			<2.4W	/	 25×95×65
A16DOR			16 Relay	<8.4W	/	
A16DOT			16 Transistor NPN	<8.4W	/	
A16DOP			16 Transistor PNP	<8.4W	/	
A16XDR	8		8 Relay	<4.8W	/	
A16XDT	8		8 Transistor NPN	<4.8W	/	
A16XDP	8		8 Transistor PNP	<4.8W	/	

Analog Expansion

Model	Specification				Dimension WxHxD(mm)		
	24VDC	AI	AO	Conversion Accuracy		Power	COM Port
A04AI	4			12bit	<2.4W	/	 25×95×65
A04AO		4		12bit	<2.4W	/	
A04XA	2	2		12bit	<2.4W	/	
A08AI	8			12bit	<2.4W	/	
A08AO		8		12bit	<3.6W	/	
A08XA	4	4		12bit	<3.6W	/	

Humidity&Temperature Expansion

Model	Specification				Dimension WxHxD(mm)
24VDC	Sensor Type	Conversion Accuracy	Power	COM Port	
A04TC	4 Thermocouple	16bit	<2.4W	/	 25×95×65
A04RC	4 Thermal Resistance	16bit	<2.4W	/	
A08TC	8 Thermocouple	16bit	<2.4W	/	
A04DT	4 Channels digital temperature & humidity sensor	9~12bit	<2.4W	/	

Communication Expansion

Model	Specification	Power	Dimension WxHxD(mm)
A01RS	With isolation, 1 RS232/RS485 communication port. Supports Modbus RTU/ASCII, Freedom communication protocol, Haiwellbus, 1200~115200bpS and 8,N,1	<2.4W	 25×95×65

Classic PLC

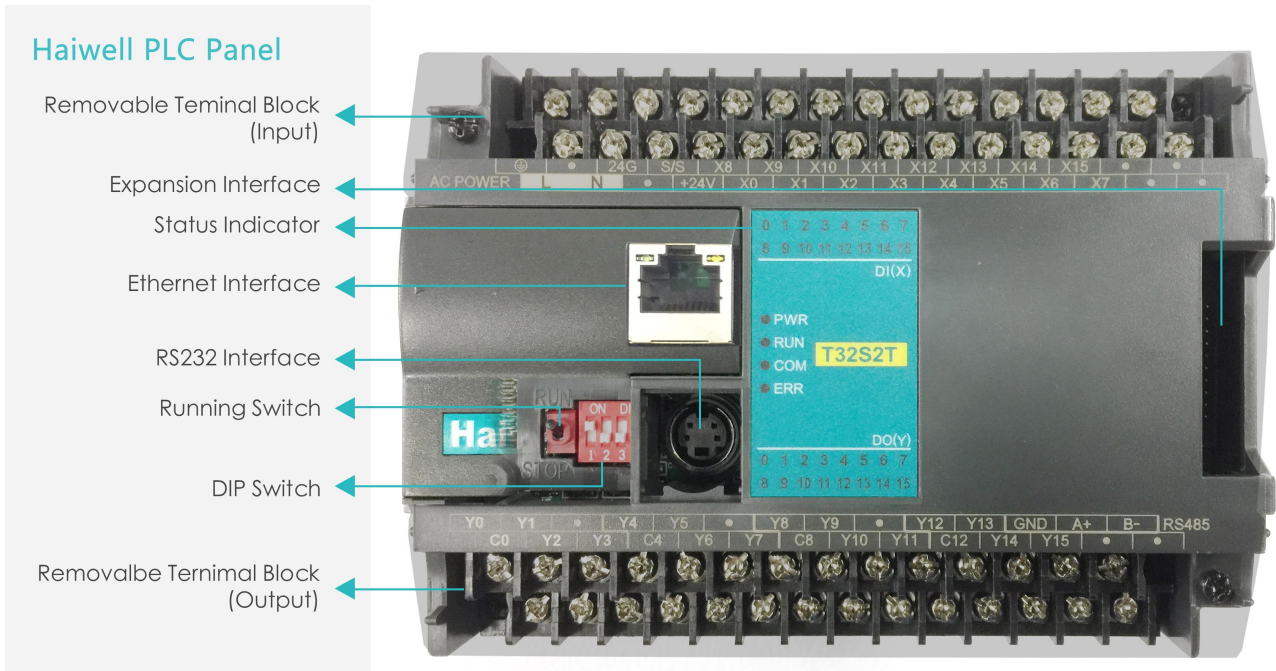

C 48 S 2 T - e

1 2 3 4 5 6

1 Series

C series PLC MPU T series PLC MPU H series PLC MPU

2 I/O Point

Built-in IO: 10-point, 16-point, 20-point, 24-point, 32-point, 40-point, 48-point and 60-point are optional

3 Specification

S: Standard Digital PLC MPU

4 Power Specification

2: 220V AC **0:** 24V DC

5 Output type

R: Relay **T:** Transistor NPN **P:** Transistor PNP





6 Ethernet

e: Built-in Ethernet port **Empty:** Without Ethernet port

PLC MPU List





Haiwell PLC main MPU have 3 series (C series, T series, H series)

C Series Classic PLC MPU (-e : Built-in Ethernet port)

Ethernet Model		Model		Specification				Dimension WxHxD
24V DC	220V AC	24V DC	220V AC	DI	DO	COM port	Max Expansion	
C10S0R-e	C10S2R-e	C10S0R	C10S2R	6	4 Relay	RS232 + RS485	N/A	 93×95×82mm
C10S0T-e	C10S2T-e	C10S0T	C10S2T	6	4 Transistor NPN	RS232 + RS485	N/A	
C10S0P-e	C10S2P-e	C10S0P	C10S2P	6	4 Transistor PNP	RS232 + RS485	N/A	
C16S0R-e	C16S2R-e	C16S0R	C16S2R	8	8 Relay	RS232 + RS485	N/A	
C16S0T-e	C16S2T-e	C16S0T	C16S2T	8	8 Transistor NPN	RS232 + RS485	N/A	
C16S0P-e	C16S2P-e	C16S0P	C16S2P	8	8 Transistor PNP	RS232 + RS485	N/A	
C24S0R-e	C24S2R-e	C24S0R	C24S2R	16	8 Relay	RS232 + RS485	N/A	 131×95×82mm
C24S0T-e	C24S2T-e	C24S0T	C24S2T	16	8 Transistor NPN	RS232 + RS485	N/A	
C24S0P-e	C24S2P-e	C24S0P	C24S2P	16	8 Transistor PNP	RS232 + RS485	N/A	
C32S0R-e	C32S2R-e	C32S0R	C32S2R	16	16 Relay	RS232 + RS485	N/A	 131×95×82mm
C32S0T-e	C32S2T-e	C32S0T	C32S2T	16	16 Transistor NPN	RS232 + RS485	N/A	
C32S0P-e	C32S2P-e	C32S0P	C32S2P	16	16 Transistor PNP	RS232 + RS485	N/A	
C48S0R-e	C48S2R-e	C48S0R	C48S2R	28	20 Relay	RS232 + RS485	N/A	 177×95×82mm
C48S0T-e	C48S2T-e	C48S0T	C48S2T	28	20 Transistor NPN	RS232 + RS485	N/A	
C48S0P-e	C48S2P-e	C48S0P	C48S2P	28	20 Transistor PNP	RS232 + RS485	N/A	
C60S0R-e	C60S2R-e	C60S0R	C60S2R	36	24 Relay	RS232 + RS485	N/A	 177×95×82mm
C60S0T-e	C60S2T-e	C60S0T	C60S2T	36	24 Transistor NPN	RS232 + RS485	N/A	
C60S0P-e	C60S2P-e	C60S0P	C60S2P	36	24 Transistor PNP	RS232 + RS485	N/A	



- ◆ MPU Points: 10/16/24/32/48/60;
- ◆ Program capacity: 48K steps;
- ◆ No expansion module function;
- ◆ Cost-effective, high-reliability and practical;
- ◆ 220VAC or 24VDC power supply;
- ◆ Use removable terminal blocks, with the rechargeable battery for saving real-time clock;
- ◆ The platform update, using ARM architecture, the processing speed increases more than 10 times;
- ◆ COM port: Built-in RS232 and RS485 ports, compatible with Modbus ASCII/RTU Protocol, Free communication Protocol and Haiwellbus high speed Protocol;
- ◆ Support Ethernet port and 2 other RS232/RS485 communication ports working simultaneously, support multilevel networking type.

T Series Classic PLC MPU (-e : Built-in Ethernet port)

Ethernet Model		Model		Specification						Dimension WxHxD
24V DC	220V AC	24V DC	220V AC	DI	DO	Pulse Input	Pulse Output	COM port	Max exp.	
T16S0R-e	T16S2R-e	T16S0R	T16S2R	8	8 Relay	2 Channels A/B phase (4 points) 200KHz		RS232+RS485 , Max 5 ports	7	 93×95×82mm
T16S0T-e	T16S2T-e	T16S0T	T16S2T	8	8 Transistor NPN	2 Channels A/B phase (4 points) 200KHz	2 Channels A/B phase (4 points) 200KHz	RS232+RS485 , Max 5 ports	7	
T16S0P-e	T16S2P-e	T16S0P	T16S2P	8	8 Transistor PNP	2 Channels A/B phase (4 points) 200KHz	2 Channels A/B phase (4 points) 200KHz	RS232+RS485 , Max 5 ports	7	
T24S0R-e	T24S2R-e	T24S0R	T24S2R	16	8 Relay	2 Channels A/B phase (4 points) 200KHz		RS232+RS485 , Max 5 ports	7	 131×95×82mm
T24S0T-e	T24S2T-e	T24S0T	T24S2T	16	8 Transistor NPN	2 Channels A/B phase (4 points) 200KHz	2 Channels A/B phase (4 points) 200KHz	RS232+RS485 , Max 5 ports	7	
T24S0P-e	T24S2P-e	T24S0P	T24S2P	16	8 Transistor PNP	2 Channels A/B phase (4 points) 200KHz	2 Channels A/B phase (4 points) 200KHz	RS232+RS485 , Max 5 ports	7	
T32S0R-e	T32S2R-e	T32S0R	T32S2R	16	16 Relay	2 Channels A/B phase (4 points) 200KHz		RS232+RS485 , Max 5 ports	7	 177×95×82mm
T32S0T-e	T32S2T-e	T32S0T	T32S2T	16	16 Transistor NPN	2 Channels A/B phase (4 points) 200KHz	2 Channels A/B phase (4 points) 200KHz	RS232+RS485 , Max 5 ports	7	
T32S0P-e	T32S2P-e	T32S0P	T32S2P	16	16 Transistor PNP	2 Channels A/B phase (4 points) 200KHz	2 Channels A/B phase (4 points) 200KHz	RS232+RS485 , Max 5 ports	7	
T48S0R-e	T48S2R-e	T48S0R	T48S2R	28	20 Relay	2 Channels A/B phase (4 points) 200KHz		RS232+RS485 , Max 5 ports	7	 177×95×82mm
T48S0T-e	T48S2T-e	T48S0T	T48S2T	28	20 Transistor NPN	2 Channels A/B phase (4 points) 200KHz	2 Channels A/B phase (4 points) 200KHz	RS232+RS485 , Max 5 ports	7	
T48S0P-e	T48S2P-e	T48S0P	T48S2P	28	20 Transistor PNP	2 Channels A/B phase (4 points) 200KHz	2 Channels A/B phase (4 points) 200KHz	RS232+RS485 , Max 5 ports	7	
T60S0R-e	T60S2R-e	T60S0R	T60S2R	36	24 Relay	2 Channels A/B phase (4 points) 200KHz		RS232 + RS485, Max 5 ports	7	 177×95×82mm
T60S0T-e	T60S2T-e	T60S0T	T60S2T	36	24 Transistor NPN	2 Channels A/B phase (4 points) 200KHz	2 Channels A/B phase (4 points) 200KHz	RS232+RS485 , Max 5 ports	7	
T60S0P-e	T60S2P-e	T60S0P	T60S2P	36	24 Transistor PNP	2 Channels A/B phase (4 points) 200KHz	2 Channels A/B phase (4 points) 200KHz	RS232+RS485 , Max 5 ports	7	

- ◆ MPU Points: 10/16/24/32/48/60;
- ◆ Program capacity: 48K steps;
- ◆ Expandable to Max. 7 Modules;
- ◆ 20VAC or 24VDC power supply;
- ◆ Use removable terminal blocks, with the rechargeable battery for saving real-time clock;
- ◆ The platform update, using ARM+FPGA architecture, the processing speed increases more than 10 times;
- ◆ 2 groups of AB phase 200KHz pulse output; 2 channels of 200KHz pulse input;
- ◆ COM port: Built-in RS232 and RS485 ports, compatible with Modbus ASCII/RTU Protocol, Free communication Protocol and Haiwellbus high speed Protocol ;
- ◆ Support Ethernet port and 5 other RS232/RS485 communication ports working simultaneously, support multilevel network type.

H Series Classic PLC MPU (-e : Built-in Ethernet port)

Ethernet Model		Model		Specification						Dimension WxHxD
24V DC	220V AC	24V DC	220V AC	DI	DO	Pulse Input	Pulse Output	COM port	Max exp.	
H16S0R-e	H16S2R-e	H16S0R	H16S2R	8	8 Relay	4 Channels A/B phase (8 points) 200KHz		RS232+RS485, Max 5 ports	7	 93×95×82mm
H16S0T-e	H16S2T-e	H16S0T	H16S2T	8	8 Transistor NPN	4 Channels A/B phase (8 points) 200KHz	4 Channels A/B phase (8 points) 200KHz	RS232+RS485, Max 5 ports	7	
H16S0P-e	H16S2P-e	H16S0P	H16S2P	8	8 Transistor PNP					
H24S0R-e	H24S2R-e	H24S0R	H24S2R	12	12 Relay	4 Channels A/B phase (8 points) 200KHz		RS232+RS485, Max 5 ports	7	
H24S0T-e	H24S2T-e	H24S0T	H24S2T	12	12 Transistor NPN	6 Channels A/B phase (12 points) 200KHz	6 Channels A/B phase (12 points) 200KHz	RS232+RS485, Max 5 ports	7	
H24S0P-e	H24S2P-e	H24S0P	H24S2P	12	12 Transistor PNP					
H32S0R-e	H32S2R-e	H32S0R	H32S2R	16	16 Relay	4 Channels A/B phase (8 points) 200KHz		RS232+RS485, Max 5 ports	7	 131×95×82mm
H32S0T-e	H32S2T-e	H32S0T	H32S2T	16	16 Transistor NPN	6 Channels A/B phase (12 points) 200KHz	6 Channels A/B phase (12 points) 200KHz	RS232+RS485, Max 5 ports	7	
H32S0P-e	H32S2P-e	H32S0P	H32S2P	16	16 Transistor PNP					
H40S0R-e	H40S2R-e	H40S0R	H40S2R	20	20 Relay	4 Channels A/B phase (8 points) 200KHz		RS232+RS485, Max 5 ports	7	
H40S0T-e	H40S2T-e	H40S0T	H40S2T	20	20 Transistor NPN	8 Channels A/B phase (16 points) 200KHz	8 Channels A/B phase (16 points) 200KHz	RS232+RS485, Max 5 ports	7	
H40S0P-e	H40S2P-e	H40S0P	H40S2P	20	20 Transistor PNP					
H60S0R-e	H60S2R-e	H60S0R	H60S2R	36	24 Relay	4 Channels A/B phase (8 points) 200KHz		RS232+RS485, Max 5 ports	7	 177×95×82mm
H60S0T-e	H60S2T-e	H60S0T	H60S2T	36	24 Transistor NPN	8 Channels A/B phase (16 points) 200KHz	8 Channels A/B phase (16 points) 200KHz	RS232+RS485, Max 5 ports	7	
H60S0P-e	H60S2P-e	H60S0P	H60S2P	36	24 Transistor PNP					

- ◆ MPU Points: 16/24/32/40/60;
- ◆ Program capacity: 48K steps;
- ◆ Expandable to Max. 7 Modules;
- ◆ 220VAC or 24VDC power supply;
- ◆ Use removable terminal blocks and use the rechargeable battery for saving real-time clock;
- ◆ The platform update, using ARM+FPGA architecture, the processing speed increases more than 10 times;
- ◆ Supports 2-axis linear /arc interpolation, 2-axis synchronous control, absolute address, relative address, backlash compensation, electric original point redefine etc.
- ◆ 8 groups of AB phase 200KHz pulse output; 8 channels of 200KHz pulse input ;
- ◆ COM port: Built-in RS232 and RS485 ports, compatible with Modbus ASCII/RTU Protocol, up to 5 communication ports and up to 7 non-communication modules;
- ◆ Support Ethernet port and 5 other RS232/RS485 communication ports working simultaneously, support multilevel network type.

PLC Expansion List



Built-in RS485 Communication port, support remote I/O function.

Digital Modules (-e : Built-in Ethernet port)

Ethernet Model	Model	Specification			Dimension WxHxD
		DI	DO	Communication	
24V DC	H08DI	8			 30×95×82mm
	H08DOR		8 Relay		
	H08DOT		8 Transistor NPN		
	H08DOP		8 Transistor PNP		
	H08XDR	4	4 Relay		
	H08XDT	4	4 Transistor NPN		
	H08XDP	4	4 Transistor PNP		
	H16DI	16		RS485,support remote IO function	 70×95×82mm
	H16DOR		16 Relay	RS485,support remote IO function	
	H16DOT		16 Transistor NPN	RS485,support remote IO function	
	H16DOP		16 Transistor PNP	RS485,support remote IO function	
	H16XDR	8	8 Relay	RS485,support remote IO function	
	H16XDT	8	8 Transistor NPN	RS485,support remote IO function	
	H16XDP	8	8 Transistor PNP	RS485,support remote IO function	
H24DI-e	H24DI	24		RS485,support remote IO function	 93×95×82mm
H24XDR-e	H24XDR	12	12 Relay	RS485,support remote IO function	
H24XDT-e	H24XDT	12	12 Transistor NPN	RS485,support remote IO function	
H24XDP-e	H24XDP	12	12 Transistor PNP	RS485,support remote IO function	
H40DI-e	H40DI	40		RS485,support remote IO function	 131×95×82mm
H36DOR-e	H36DOR		36 Relay	RS485,support remote IO function	
H36DOT-e	H36DOT		36 Transistor NPN	RS485,support remote IO function	
H36DOP-e	H36DOP		36 Transistor PNP	RS485,support remote IO function	
H40XDR-e	H40XDR	20	20 Relay	RS485,support remote IO function	 177×95×82mm
H40XDT-e	H40XDT	20	20 Transistor NPN	RS485,support remote IO function	
H40XDP-e	H40XDP	20	20 Transistor PNP	RS485,support remote IO function	
H64XDR-e	H64XDR	32	32 Relay	RS485,support remote IO function	 177×95×82mm
H64XDT-e	H64XDT	32	32 Transistor NPN	RS485,support remote IO function	
H64XDP-e	H64XDP	32	32 Transistor PNP	RS485,support remote IO function	



- ◆ MPU Points: 8/16/24/36/40/64;
- ◆ It can be used as expansion module for any Haiwell PLC;
- ◆ Digital modules with more than 8-point have RS485 port, support stand-alone use and can also be used for Remote IO;
- ◆ Expansion modules with Ethernet port and RS485 port, can be remote IO unit by distributed installation.

Analog Modules (-e : Built-in Ethernet port)

Ethernet Model	Model	Specification				Dimension WxHxD
		AI	AO	Conversion Accuracy	Communication	
24V DC	S04AI	4		12 bits	RS485, support remote IO function	 70×95×82mm
	S04AO		4	12 bits	RS485, support remote IO function	
	S04XA	2	2	12 bits	RS485, support remote IO function	
S08AI-e	S08AI	8		12 bits	RS485, support remote IO function	 93×95×82mm
S08AO-e	S08AO		8	12 bits	RS485, support remote IO function	
S08XA-e	S08XA	4	4	12 bits	RS485, support remote IO function	

- ◆ Can be used as extension module for any Haiwell PLC host;
- ◆ Modules with RS485 port can be use as remote I/O;
- ◆ AI, AO supports signal types: [4,20]mA, [1,5]V, [0,20]mA, [0,5]V, [0,10]V,;
- ◆ Expansion modules with Ethernet port and RS458 port, can be remote IO unit by distributed installation.

Temperature and Humidity Modules (-e : Built-in Ethernet port)

Ethernet Model	Model	Specification			Dimension WxHxD
		Sensor Type	Conversion Accuracy	Communication	
24V DC	H04DT	4 Channels DS18B20, RW1820 temperature sensor, DS1990 sensor or SHT1x, SHT7x temperature & humidity sensor	9~12 bits		 30×95×82mm
	H32DT	32 Channels DS18B20, RW1820 temperature sensor, DS1990 sensor	9~12 bits	RS485, support remote IO function	
	H04RC	4 Thermal resistance	16 bits	RS485, support remote IO function	 70×95×82mm
	H04TC	4 Thermocouple	16 bits	RS485, support remote IO function	
	H08TC	8 Thermocouple	16 bits	RS485, support remote IO function	
H08RC-e	H08RC	8 Thermal resistance	16 bits	RS485, support remote IO function	 93×95×82mm

- ◆ Can be used as extension module for any Haiwell PLC host;
- ◆ Modules with RS485 port can be use as remote I/O;
- ◆ Thermal Resistance kinds: PT100,PT1000, Cu50,Cu100;
- ◆ Thermocouple kinds: S, K, T, E, J, B, N, R, Wre3/25, Wre5/26, [0,20]mV, [0,50]mV, [0,100]mV;
- ◆ Expansion modules with Ethernet port and RS458 port, can be remote IO unit by distributed installation.

Weighing Modules

Model	Specification				Dimension WxHxD	
	24V DC	Type	Specification	Conversion Accuracy		Communication
H01WG		Weighing Module	1 channel weighing	24 bits	RS485, support remote IO function	 30×95×82mm
H02WG		Weighing Module	2 channel weighing	24 bits	/	

Communication Modules

Model	Specification	Dimension WxHxD
S01RS	With isolation ,1 RS232/RS485 communication port, Modbus RTU/ASCII protocol, freedom communication protocol, Haiwellbus high speed communication protocol, Baud rate 1200~57600bps	 30×95×82mm

- ◆ Power supply: internal 24VDC;
- ◆ Baud rate 1200~115200bps, master/slave mode can be used well;
- ◆ Support Modbus RTU/ASCII protocol, free communication protocol, HaiwellBus high-speed communication protocol;
- ◆ It can be used as expansion module for any host, except C series PLC, increasing the number of communication ports;
- ◆ Single communication port module can be extended to two or three communication ports, RS485/RS232 port optionally.

Accessories

Model	Specification	Dimension
ACA20	RS232 programming cable (DB9, length 2 meters)	 2.0m

Wiring Diagram:

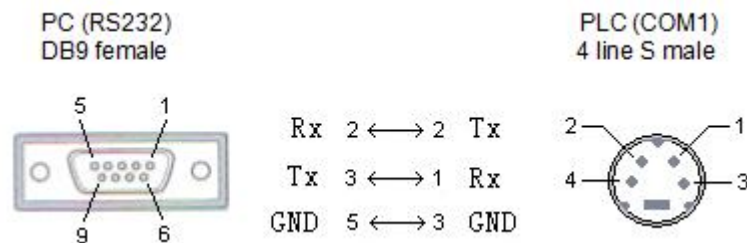

Specification

Haiwell PLC Specification

Item		Specification	Declare
Program control model		Cycle scan model	
Input/output (I/O) control model		Refresh once each cycle scan, support immediately refresh instruction (MPU and expansion module)	
Execution speed of instruction		0.05μs/basic instruction	
Program language		LD (ladder) + FBD (function block) + IL (instruction list)	Accord with IEC 61131-3
Program capacity		48K	
Storage way		Flash ROM permanent storage, dispense with backup battery	
X	External input	X0~X1023	Support edge catch and signal filtering set
Y	External output	Y0~Y1023	Power-off preserve output can be configured
M	Auxiliary relay	M0~ M12287	Power-off preserve area can be set freedom
		(default power-off preserve) M1536~M2047	
T	Timer (output coil)	T0~T1023	Power-off preserve area can be set freedom, time base: 10ms, 100ms, 1s be set freedom, T252~T255 1ms
		(default power-off preserve) T96~T127	
C	Counter (output coil)	C0~C255	Power-off preserve area can be set freedom
		(default power-off preserve) C64~C127	
S	Step state bits	S0~S2047	Power-off preserve area can be set Freedom
		(default power-off preserve) S156~S255	
SM	System state bits	SM0~SM215	
LM	Local relay	LM~LM31	
AI	Analog input register	AI0~AI255	Support quantities convert, sample times and zero point correct
AQ	Analog output register	AQ0~AQ255	Support quantities convert, power-off preserve output can be configured
V	Internal data register	V0~V14847	power-off preserve area can be set freedom
		(default power-off preserve) V1000~V2047	
TV	Timer (Current value register)	TV0~TV1023	Power-off preserve area can be set freedom, time base: 10ms, 100ms, 1s can be set freedom, T252~T255 1ms
		(default power-off preserve) TV96~TV127	
CV	Counter (Current value register)	CV0~CV255	Power-off preserve area can be set freedom, CV48~CV79 are 32 bits, Other are 16 bits
		(default power-off preserve) CV64~CV127	
SV	System register	SV0~SV900	

Lv	Local Register	Lv0~Lv31	
P	Indexed addressing point	P0~P29 ,use for indirect addressing	
I	Interrupt	I1-I52	
LBL	Lable	255,use for program skip	
Constant	10 Decimal	-32768~+32767(16 bits),-2147483648~+2147483647(32 bits)	
	16 Hexadecimal	0000~FFFF(16 bits), 00000000~FFFFFFFF(32 bits)	
Communication port		MPU built-in 2 communication port(RS232/RS485), Max 5 communication port (RS232/RS485) expansion	can be used for program or networking(master/slave)
Communication protocol		Modbus RTU/ASCII protocol, freedom communication protocol, Haiwellbus speed communication protocol, Baud rate 1200~115200bps	
PLC network capacity		PLC communication address can be set external set, Max 254, support multilevel networking	
Real time clock(RTC)		Display: year/month/day/hour/minute/second/week	built-in battery
High speed counter		8 Channels, 200KHz	Have teaching function, 7 counting model: 1 - pulse/direction 1 times, 2 - pulse/direction 2 times, 3 - positive/reversal pulse 1 times, 4 - positive/reversal pulse 2 times, 5 - A/B phase pulse 1 times, 6 - A/B phase pulse 2 times, 7 - A/B phase pulse 4 times
High speed pulse output		8 Channels, 200KHz	5 output models: 1 - single pulse output, 2 - pulse/direction output, 3 - positive/reversal pulse output, 4 - A/B phase pulse output, 5 - Synchronism pulse output
Float point arithmetic instruction		support within 32 bits float point arithmetic, integer/float point convert arithmetic	
Password protect		Support three level password protect function(program file password, program block password, PLC hardware password) and upload prohibited function	

Power Specification

Item		AC Supply	DC Supply
Input power supply		100~240VAC	24VDC -15%~+20%
Power supply frequency		50~60Hz	---
Instant surge		MAX 20A 1.5ms @220VAC	MAX 20A 1.5ms @24VDC
Power output		MAX 25VA	---
Permit Power supply lost		20ms within @220VAC	10ms within
Fuse capacity		2A,250V	2A,250V
Action (working) specification		When input power voltage rise to 95~100VAC, PLC will be run, when input power voltage drop down to 70VAC, PLC will be stopped.	---
Output power supply	5VDC for CPU	5V,-2%~+2%,1.2A(maximum)	5V,-2%~+2%,1.2A(maximum)
	24VDC power supply for output and expansion modules	24V,-15%~+15%,500 mA(maximum)	24V,-15%~+15%,500mA(maximum)
	24VDC power supply for input and external device	24V,-15%~+15%,200mA(maximum)	Direct use the 24VDC input power supply
Isolation model		Transformer/photo electricity isolation,1500VAC/1 minute	No electrical isolation
Protect the power supply		24VDC output over the limit of the current	DC power input polar against, over voltage

Product Environment Specification

Item	Environment Specification
Temperature/Humidity	Working temperature: 0 ~ + 55 °C storage temperature: - 25 ~ + 70 °C and humidity: 5 ~ 95% RH, no condensation
Anti vibration	10~57Hz range 0.075mm,57Hz~150Hz acceleration 1G,X, Y, Z three axis 10 times each direction
Anti shock	15G,continue 11ms,X, Y, Z three axis 6 times each direction
Anti jamming	AC EFT: ± 2500V, surge: ± 2500V, DC EFT: ±2500V, surge: ±1000V
Over voltage capability	Between AC terminal and PE terminal 1500VAC,1min,Between DC terminal and PE terminal 500VAC,1min
Insulation impedance	Between AC terminal and PE terminal@500VDC,>=5MΩ(Between all input/output terminal and PE terminal@500VDC)
Earth	The third grounding(Cannot connect to the strong power system's earth)
Operation environment	Operated where no dust, moisture, corrosion, electrical shock and physical shock ,etc.

Digital Input (DI) Specification

Item	Digital Input DI
Input signal	Non-voltage contact or NPN/PNP contact
Action driving	ON: 3.5 mA above OFF: below 1.5 mA
Input impedance	About 4.3KΩ
Input maximum current	10mA
Response time	Default 6.4ms,Configurable 0.8~51.2ms
Isolation mode	Each Channel optical isolation
Input indication	LED light means ON, dark means OFF
Power supply	PLC internal power supply: DC power(sink or source)5.3mA@24VDC

Digital Output (DO) Specification

Item		Relay Output-R	NPN or PNP transistor output - T/P
maximum load	Resistance load	2A/1 point,8A/4 point per COM	0.5A/1 point,2A/4 point per COM
	Inductive load	50VA	5W/24VDC
	Light load	100W	12W/24VDC
Min. load		10mA	2mA
Voltage specification		Below 250VAC,30VDC	30VDC
Drive capability		Maximum 5A/250VAC	MAX 1A 10S
Response time		Off-on 10ms,On-off 5ms	Off→On 10μs, On→Off 120μs
Leakage current when route opened		---	Below 0.1mA
Isolation mode		Mechanical isolation	Each Channel optical isolation
Output indication		LED light means ON , dark means OFF	
Power supply		PLC internal power supply 24VDC	

Analog Input (AI) Specification

Properties		Voltage input			Current input	
Input range		0V~+10V	0V~+5V	1V~+5V	0~20mA	4~20mA
Max. allowed input		13V			30mA	
Range of digital value		0-32000	0-32000	0-32000	0-32000	0-32000
Input impedance		6MΩ			250Ω	
Response time		2.0ms/ch				
Resolution		16 bits				
Basic error	Room temperature 25±5℃	±0.20%				
	Full temperature range	±0.5%				
Linearity error	Room temperature 25±5℃	±0.10%				
	Full temperature range	±0.10%				
Status display		If the channel is normal, the indicator light will be on.				
Diagnostics function		If disconnection or limit-exceeding (≥110%FS) is detected, the indicator light will be off.				
Isolation		Isolation between an analog circuit and a digital circuit No isolation between channels				
Power supply		24VDC ±20%, 200mA (Max.)				

Notices:

1. If the input signal exceeds the input range, the digital value will be 32000.
2. If the input signal exceeds the maximum allowed voltage or current, the channel might be damaged.
3. It is not allowed to connect the wire inversely.

Analog Output (AO) Specification

Properties		Voltage output			Current output	
Output range		0V~ +10V	0V~+5V	1V~+5V	0~20mA	4~20mA
Range of digital value		0-32000	0-32000	0-32000	0-32000	0-32000
Load impedance		1KΩ@10V	≥500Ω@ 10V		≤500Ω	
Response time		3.0ms/ch				
Resolution		12 bits				
Basic error	Room temperature 25±5℃	±0.30%				
	Full temperature range	±0.60%				
Linearity error	Room temperature 25±5℃	±0.20%				
	Full temperature range	±0.20%				
Status display		If the channel is normal, the indicator light will be on.				
Isolation		Isolation between an analog circuit and a digital circuit No isolation between channels				
Power supply		24VDC ±20%, 200mA (Max.)				
Notices: 1. If the load doesn't meet the requirement, the accuracy of output might be effected. 2. If there is short-circuit or voltage backflow, the channel might be damaged.						

Temperature module (RC) specifications

Properties	04RC/08RC	
Supported sensor types	Pt100, Pt1000, Cu50, Cu100	
Overall accuracy	Pt100 / Pt1000: Room temperature (25±5°C): ±0.1%±1°C Full temperature range: ±0.5%±1°C	
	Cu50: ±4°C at room temperature (25±5°C)	
	Cu100: ±2°C at room temperature (25±5°C)	
Resolution	0.1°C	
Response time	560ms/4ch	
Range of digital value	16 bits, 0-32000	
Input impedance	6MΩ	
Status display	If the channel is normal, the indicator light will be on.	
Diagnostics function	If disconnection is detected, the indicator light will be off.	
Isolation	Isolation between an analog circuit and a digital circuit No isolation between channels	
Power supply	24VDC ±20%, 200mA (Max.)	
Functional specifications		
	Celsius (°C)	Input impedance
Rated input range	Pt100: -180°C~800°C	0~300Ω 0~3000Ω
	Pt1000: -180°C~800°C	
	Cu50: -50°C~150°C	
	Cu100: -50°C~150°C	

Temperature module (TC) specifications

Properties	04TC/08TC	
Supported sensor types	Type S, Type K, Type T, Type E, Type J, Type B, Type N, Type R Wre3/25, Wre5/26 0-20mV, 0-50mV, 0-100mV	
Overall accuracy	Room temperature(25±5°C): ±0.2%±2°C	
	Full temperature range: ±0.5%±2°C	
Resolution	0.1°C	
Response time	560ms/4ch	
Range of digital value	16 bits, 0-32000	
Input impedance	6MΩ	
Status display	If the channel is normal, the indicator light will be on.	
Diagnostics function	If disconnection is detected, the indicator light will be off.	
Isolation	Isolation between an analog circuit and a digital circuit No isolation between channels	
Power supply	24VDC ±20%, 200mA (Max.)	
	Functional specifications	
	Celsius (°C)	Input impedance
Rated input range	Type S: 0°C~1700°C	-10mV~+100mV
	Type K: -200°C~1300°C	
	Type T: -200°C~400°C	
	Type E: -200°C~1000°C	
	Type J: -200°C~1200°C	
	Type B: 250°C~1820°C	
	Type N: -200°C~1300°C	
	Type R: 0°C~1700°C	
	Wre3/25 (Type D): 0°C~2300°C	
	Wre5/26 (Type C): 0°C~2300°C	

Expansion Modules Parameter

4 Channels Analog Modules Parameter Table

Note: CR number corresponding the Modbus register address, the grey parts are read-only, the white parts are readable and writable.

CR Number	Function Declare				
	S04AI	S04AO	S04XA	H04RC	H04TC
00H	The low byte is the module code, and the high byte is the module version number.				
01H	Communication address				
02H	Communication protocol: The low 4-bit of the low byte: 0 - N,8, 2 For RTU, 1 - E,8,1 For RTU, 2 - O,8,1 For RTU, 3 - N,7,2 For ASCII, 4 - E,7,1 For ASCII, 5 - O,7,1 For ASCII, 6 - N,8, 1 For RTU The high 4-bit of the low byte: 0 - 2400, 1 - 4800, 2 - 9600, 3 - 19200, 4 - 38400, 5 - 57600, 6 - 115200				
03H~06H	Extend module name				
07H~08H	Default IP address: 192.168.1.111				
09~0AH	Reserve				
0BH	High byte subnet mask (b3~b0,1 indicates 255, 0 indicates 0, for example subnet mask 255.255.255.0, b3~b0=1110), low byte reserved				
0CH~0EH	Reserve				
0FH	Error code: 0-Normal, 1-Illegal firmware identity, 2-Incomplete firmware, 3-System data access exception, 4-No external 24V power supply				
10H	The input value of channel 1	The output value of channel 1	The input value of channel 1	The input value of channel 1	The input value of channel 1
11H	The input value of channel 2	The output value of channel 2	The input value of channel 2	The input value of channel 2	The input value of channel 2
12H	The input value of channel 3	The output value of channel 3	The signal type of input channel 1, note 2	The input value of channel 3	The input value of channel 3
13H	The input value of channel 4	The output value of channel 4	The signal type of input channel 2, note 2	The input value of channel 4	The input value of channel 4
14H	The signal type of channel 1, note 2	The signal type of channel 1, note 2	Use the engineering value mark, note 6	The signal type of channel 1, note 3	The signal type of channel 1, note 4
15H	The signal type of channel 2, note 2	The signal type of channel 2, note 2	The lower limit in engineering value of input channel 1	The signal type of channel 2, note 3	The signal type of channel 2, note 4
16H	The signal type of channel 3, note 2	The signal type of channel 3, note 2	The lower limit in engineering value of input channel 2	The signal type of channel 3, note 3	The signal type of channel 3, note 4
17H	The signal type of channel 4, note 2	The signal type of channel 4, note 2	The upper limit in engineering value of input channel 1	The signal type of channel 4, note 3	The signal type of channel 4, note 4
18H	Use the engineering value mark, note 6	Use the engineering value mark, note 6	The upper limit in engineering value of input channel 2	Use the engineering value mark, note 6	Use the engineering value mark, note 6
19H	The lower limit in engineering value of channel 1	The lower limit in engineering value of channel 1	The sampling frequency of input channel 1	The lower limit in engineering value of channel 1	The lower limit in engineering value of channel 1
1AH	The lower limit in engineering value of channel 2	The lower limit in engineering value of channel 2	The sampling frequency of input channel 2	The lower limit in engineering value of channel 2	The lower limit in engineering value of channel 2
1BH	The lower limit in engineering value	The lower limit in engineering value	zero point correction value of input	The lower limit in engineering value of	The lower limit in engineering value of

	of channel 3	of channel 3	channel 1	channel 3	channel 3
1CH	The lower limit in engineering value of channel 4	The lower limit in engineering value of channel 4	zero point correction value of input channel 2	The lower limit in engineering value of channel 4	The lower limit in engineering value of channel 4
1DH	The upper limit in engineering value of channel 1	The upper limit in engineering value of channel 1	Channel 1~2 input disconnection alarm, note 5	The upper limit in engineering value of channel 1	The upper limit in engineering value of channel 1
1EH	The upper limit in engineering value of channel 2	The upper limit in engineering value of channel 2	The output value of output channel	The upper limit in engineering value of channel 2	The upper limit in engineering value of channel 2
1FH	The upper limit in engineering value of channel 3	The upper limit in engineering value of channel 3	The output value of channel 2	The upper limit in engineering value of channel 3	The upper limit in engineering value of channel 3
20H	The upper limit in engineering value of channel 4	The upper limit in engineering value of channel 4	The signal type of output channel 1, note 2	The upper limit in engineering value of channel 4	The upper limit in engineering value of channel 4
21H	The sampling frequency of channel 1, note 1	Power-off output mark, note 8	The signal type of output channel 2, note 2	The sampling frequency of channel 1, note 1	The sampling frequency of channel 1, note 1
22H	The sampling frequency of channel 2, note 1	The power-off output value of channel 1	Use the engineering value mark, note 6	The sampling frequency of channel 2, note 1	The sampling frequency of channel 2, note 1
23H	The sampling frequency of channel 2, note 1	The power-off output value of channel 2	The lower limit in engineering value of output channel 1	The sampling frequency of channel 3, note 1	The sampling frequency of channel 3, note 1
24H	The sampling frequency of channel 2, note 1	The power-off output value of channel 3	The lower limit in engineering value of output channel 2	The sampling frequency of channel 4, note 1	The sampling frequency of channel 4, note 1
25H	The zero point correction value of channel 1	The power-off output value of channel 4	The upper limit in engineering value of output channel 1	The zero point correction value of channel 1	The zero point correction value of channel 4
26H	The zero point correction value of channel 1	Channel indicator status, note 7	The upper limit in engineering value of output channel 2	The zero point correction value of channel 2	The zero point correction value of channel 2
27H	The zero point correction value of channel 3	Reserve	The power-off output mark, note 8	The zero point correction value of channel 3	The zero point correction value of channel 3
28H	The zero point correction value of channel 4		The power-off output value of output channel 1	The zero point correction value of channel 4	The zero point correction value of channel 4
29H	Channel 1~4 input disconnection alarm, note 5		The power-off output value of output channel 2	Channel 1~4 input disconnection alarm, note 5	Channel 1~4 input disconnection alarm, note 5
2AH	Reserve		The output channel indicator, note 7	Reserve	Reserve
2BH~2FH			Reserve		

Note:

- Sampling frequency: 0 - 2 times、1 - 4 times、2 - 8 times、3 - 16 times、4 - 32 times、5 - 64 times、6 - 128 times、7 - 256 times
- Signal type: 0 - [4,20]mA、1 - [0,20]mA、2 - [-1,5]V、3 - [0,5]V、4 - [0,10]V
- The signal type of thermal resistance: 0 - Pt100、1 - Pt1000、2 - Cu50、3 - Cu100
- The signal type of thermocouple: 0 - S、1 - K、2 - T、3 - E、4 - J、5 - B、6 - N、7 - R、8 - Wre3/25、9 - Wre5/26、10 - [0,20]mV、11 - [0,50]mV、12 - [0,100]mV
- Disconnection alarm: Each bit indicates 1 channel, 0-normal, 1-disconnection
- Use the engineering value mark: Each bit indicates 1 channel, 0-No, 1-Yes
- Channel indicator status: Each bit indicates 1 channel, 0-off, 1-on
- Power-off output mark: Each bit indicates 1 channel, 0-No, 1-Yes
- The output flag while power supply lost: each bits signify 1 Channel ,0-No,1-Yes

8 Channels Analog Modules Parameter Table

Note: CR number corresponding the Modbus register address, the grey parts are read-only, the white parts are readable and writable.

CR Number	Function Declare				
	S08AI	S08AO	S08XA	H08RC	H08TC
00H	The low byte is the module code, and the high byte is the module version number.				
01H	Communication address				
02H	Communication protocol: The low 4-bit of the low bytes: 0 - N,8,2 For RTU, 1 - E,8,1 For RTU, 2 - O,8,1 For RTU, 3 - N,7,2 For ASCII, 4 - E,7,1 For ASCII, 5 - O,7,1 For ASCII, 6 - N,8, 1 For RTU The high 4-bit of the low bytes: 0 - 2400, 1 - 4800, 2 - 9600, 3 - 19200, 4 - 38400, 5 - 57600, 6 - 115200				
03H~06H	Extend module name				
07H~08H	Default IP address: 192.168.1.111				
09~0AH	Reserve				
0BH	High byte subnet mask(b3~b0,1 indicates 255,0 indicates 0 , for example, subnet mask 255.255.255.0, b3~b0=1110), low byte Reserved				
0CH~0EH	Reserve				
0FH	Error code: 0-Normal, 1-Illegally firmware identity, 2-Incomplete firmware, 3-System data access exception, 4-No external 24V power supply				
10H	The input value of channel 1	The output value of channel 1	The input value of channel 1	The input value of channel 1	The input value of channel 1
11H	The input value of channel 2	The output value of channel 2	The input value of channel 2	The input value of channel 2	The input value of channel 2
12H	The input value of channel 3	The output value of channel 3	The input value of channel 3	The input value of channel 3	The input value of channel 3
13H	The input value of channel 4	The output value of channel 4	The input value of channel 4	The input value of channel 4	The input value of channel 4
14H	The input value of channel 5	The output value of channel 5	The signal type of input channel 1, note 2	The input value of channel 5	The input value of channel 5
15H	The input value of channel 6	The output value of channel 6	The signal type of input channel 2, note 2	The input value of channel 6	The input value of channel 6
16H	The input value of channel 7	The output value of channel 7	The signal type of input channel 3, note 2	The input value of channel 7	The input value of channel 7
17H	The input value of channel 8	The output value of channel 8	The signal type of input channel 4, note 2	The input value of channel 8	The input value of channel 8
18H	The signal type of channel 1, note 2	The signal type of channel 1, note 2	Use the engineering value mark, note 6	The signal type of channel 1, note 3	The signal type of channel 1, note 4
19H	The signal type of channel 2, note 2	The signal type of channel 2, note 2	The lower limit in engineering value of input channel 1	The signal type of channel 2, note 3	The signal type of channel 2, note 4
1AH	The signal type of channel 1, note 2	The signal type of channel 1, note 2	The lower limit in engineering value of input channel 2	The signal type of channel 3, note 3	The signal type of channel 3, note 4
1BH	The signal type of channel 4, note 2	The signal type of channel 4, note 2	The lower limit in engineering value of input channel 3	The signal type of channel 4, note 3	The signal type of channel 4, note 4
1CH	The signal type of channel 5, note 2	The signal type of channel 5, note 2	The lower limit in engineering value of input channel 4	The signal type of channel 5, note 3	The signal type of channel 5, note 4

1DH	The signal type of channel 6, note 2	The signal type of channel 6, note 2	The upper limit in engineering value of input channel 1	The signal type of channel 6, note 3	The signal type of channel 6, note 4
1EH	The signal type of channel 7, note 2	The signal type of channel 7, note 2	The upper limit in engineering value of input channel 2	The signal type of channel 7, note 3	The signal type of channel 7, note 4
1FH	The signal type of channel 8, note 2	The signal type of channel 8, note 2	The upper limit in engineering value of input channel 3	The signal type of channel 8, note 3	The signal type of channel 8, note 4
20H	Use the engineering value mark, note 6	Use the engineering value mark, note 6	The upper limit in engineering value of input channel 4	Use the engineering value mark, note 6	Use the engineering value mark, note 6
21H	The lower limit in engineering value of channel 1	The lower limit in engineering value of channel 1	The sampling frequency of input channel 1, note 1	The lower limit in engineering value of channel 1	The lower limit in engineering value of channel 1
22H	The lower limit in engineering value of channel 2	The lower limit in engineering value of channel 2	The sampling frequency of input channel 2, note 1	The lower limit in engineering value of channel 2	The lower limit in engineering value of channel 2
23H	The lower limit in engineering value of channel 3	The lower limit in engineering value of channel 3	The sampling frequency of input channel 3, note 1	The lower limit in engineering value of channel 3	The lower limit in engineering value of channel 3
24H	The lower limit in engineering value of channel 4	The lower limit in engineering value of channel 4	The sampling frequency of input channel 4, note 1	The lower limit in engineering value of channel 4	The lower limit in engineering value of channel 4
25H	The lower limit in engineering value of channel 5	The lower limit in engineering value of channel 5	The zero point correction value of input channel 1	The lower limit in engineering value of channel 5	The lower limit in engineering value of channel 5
26H	The lower limit in engineering value of channel 6	The lower limit in engineering value of channel 6	The zero point correction value of input channel 2	The lower limit in engineering value of channel 6	The lower limit in engineering value of channel 6
27H	The lower limit in engineering value of channel 7	The lower limit in engineering value of channel 7	The zero point correction value of input channel 3	The lower limit in engineering value of channel 7	The lower limit in engineering value of channel 7
28H	The lower limit in engineering value of channel 8	The lower limit in engineering value of channel 7	The zero point correction value of input channel 4	The lower limit in engineering value of channel 8	The lower limit in engineering value of channel 8
29H	The upper limit in engineering value of channel 1	The upper limit in engineering value of channel 1	Channel 1~4 input disconnection alarm, note 5	The upper limit in engineering value of channel 1	The upper limit in engineering value of channel 1
2AH	The upper limit in engineering value of channel 2	The upper limit in engineering value of channel 2	The output value of output channel 1	The upper limit in engineering value of channel 2	The upper limit in engineering value of channel 2
2BH	The upper limit in engineering value of channel 3	The upper limit in engineering value of channel 3	The output value of output channel 2	The upper limit in engineering value of channel 3	The upper limit in engineering value of channel 3
2CH	The upper limit in engineering value of channel 4	The upper limit in engineering value of channel 4	The output value of output channel 3	The upper limit in engineering value of channel 4	The upper limit in engineering value of channel 4
2DH	The upper limit in engineering value of channel 5	The upper limit in engineering value of channel 5	The output value of output channel 4	The upper limit in engineering value of channel 5	The upper limit in engineering value of channel 5

2EH	The upper limit in engineering value of channel 6	The upper limit in engineering value of channel 1	The signal type of output channel 1, note 2	The upper limit in engineering value of channel 6	The upper limit in engineering value of channel 6
2FH	The upper limit in engineering value of channel 7	The upper limit in engineering value of channel 7	The signal type of output channel 2, note 2	The upper limit in engineering value of channel 7	The upper limit in engineering value of channel 7
30H	The upper limit in engineering value of channel 8	The upper limit in engineering value of channel 1	The signal type of output channel 3, note 2	The upper limit in engineering value of channel 8	The upper limit in engineering value of channel 8
31H	The sampling frequency of channel 1, note 1	Power-off output mark, note 8	The signal type of output channel 4, note 2	The sampling frequency of channel 1, note 1	The sampling frequency of channel 1, note 1
32H	The sampling frequency of channel 2, note 1	The power-off output value of channel 1	Use the engineering value mark, note 6	The sampling frequency of channel 2, note 1	The sampling frequency of channel 2, note 1
33H	The sampling frequency of channel 3, note 1	The power-off output value of channel 2	The lower limit in engineering value of output channel 1	The sampling frequency of channel 3, note 1	The sampling frequency of channel 3, note 1
34H	The sampling frequency of channel 4, note 1	The power-off output value of channel 3	The lower limit in engineering value of output channel 2	The sampling frequency of channel 4, note 1	The sampling frequency of channel 4, note 1
35H	The sampling frequency of channel 5, note 1	The power-off output value of channel 4	The lower limit in engineering value of output channel 3	The sampling frequency of channel 5, note 1	The sampling frequency of channel 5, note 1
36H	The sampling frequency of channel 6, note 1	The power-off output value of channel 5	The lower limit in engineering value of output channel 4	The sampling frequency of channel 6, note 1	The sampling frequency of channel 6, note 1
37H	The sampling frequency of channel 7, note 1	The power-off output value of channel 6	The upper limit in engineering value of output channel 1	The sampling frequency of channel 7, note 1	The sampling frequency of channel 7, note 1
38H	The sampling frequency of channel 8, note 1	The power-off output value of channel 7	The upper limit in engineering value of output channel 2	The sampling frequency of channel 8, note 1	The sampling frequency of channel 8, note 1
39H	The zero point correction value of channel 1	The power-off output value of channel 8	The upper limit in engineering value of output channel 3	The zero point correction value of channel 1	The zero point correction value of channel 1
3AH	The zero point correction value of channel 2	Channel indicator status, note 7	The upper limit in engineering value of output channel 4	The zero point correction value of channel 2	The zero point correction value of channel 2
3BH	The zero point correction value of channel 3	Reserve	The power-off output mark, note 8	The zero point correction value of channel 3	The zero point correction value of channel 3
3CH	The zero point correction value of channel 4		The power-off output value of output channel 1	The zero point correction value of channel 4	The zero point correction value of channel 4
3DH	The zero point correction value of channel 5		The power-off output value of output channel 2	The zero point correction value of channel 5	The zero point correction value of channel 5
3EH	The zero point correction value of channel 6		The power-off output value of output channel 3	The zero point correction value of channel 6	The zero point correction value of channel 6
3FH	The zero point correction value of channel 7		The power-off output value of output channel 4	The zero point correction value of channel 7	The zero point correction value of channel 7

40H	The zero point correction value of channel 8		Output channel indicator, note 7	The zero point correction value of channel 8	
41H	Channel 1~8 input disconnection alarm, note 5		Reserve	Channel 1~8 input disconnection, note 5	Channel 1~8 input disconnection alarm, note 5
42H~4FH	Reserve			Reserve	Reserve

Note:

- Sampling frequency: 0 - 2 times、1 - 4 times、2 - 8 times、3 - 16 times、4 - 32 times、5 - 64 times、6 - 128 times、7 - 256 times
- Signal type: 0 - [4,20]mA、1 - [0,20]mA、2 - [1,5]V、3 - [0,5]V、4 - [0,10]V
- The signal type of thermal resistance: 0 - Pt100、1 - Pt1000、2 - Cu50、3 - Cu100
- The signal type of thermocouple: 0 - S、1 - K、2 - T、3 - E、4 - J、5 - B、6 - N、7 - R、8 - Wre3/25、9 - Wre5/26、10 - [0,20]mV、11 - [0,50]mV、12 - [0,100]mV
- Disconnection alarm: Each bit indicates 1 channel, 0-normal, 1-disconnection
- Use the engineering value mark: Each bit indicates 1 channel, 0-No, 1-Yes
- Channel indicator status: Each bit indicates 1 channel, 0-off, 1-on
- Power-off output mark: Each bit indicates 1 channel, 0-No, 1-Yes
- The output flag while power supply lost: each bits signify 1 Channel ,0-No,1-Yes

Digital Modules Parameter Table

Note: CR number corresponding the Modbus register address),the grey parts are read-only, the white parts are readable and writable.

CR Number	Function Declare
	H16DI, H16DOR, H16DOT, H16XDR, H16XDT, H24DI, H24XDR, H24XDT, H40DI, H36DOR, H36DOT, H40XDR, H40XDT, H64XDR, H64XDT
00H	The low byte is the module code, and the high byte is the module version number.
01H	Communication address
02H	Communication protocols:The low 4-bit of the low bytes: 0 - N,8,2 For RTU, 1 - E,8,1 For RTU, 2 - O,8,1 For RTU, 3 - N,7,2 For ASCII, 4 - E,7,1 For ASCII, 5 - O,7,1 For ASCII, 6 - N,8, 1 For RTU The high 4-bit of the low bytes: 0 – 2400, 1 – 4800, 2 – 9600, 3 – 19200, 4 – 38400, 5 – 57600, 6 - 115200
03H~06H	Extend module name
07H~08H	Default IP address: 192.168.1.111
09~0AH	Reserve
0BH	High byte subnet mask (b3~b0,1 indicates 255, 0 indicates 0, for example, subnet mask 255.255.255.0, b3~b0=1110), low byte reserved
0CH~0EH	Reserve
0FH	Error code : 0-normal, 1-illegal firmware identity ,2-incomplete firmware, 3-system data access exception, 4-No external 24V power supply
10H~4FH	DI channel 1~64 input value
50H~8FH	DO channel 1~64 output value
90H	Filtering time of DI ms, 0 - 0.8、 1 - 1.6、 2 - 3.2、 3 - 6.4、 4 - 12.8、 5 - 25.6、 6 - 51.2
91H~9FH	Reserve

Digital Temperature Module Parameter Table

Note: CR number corresponding the Modbus register address), the grey parts are read-only, the white parts are readable and writable.

CR Number	H04DT Function Declare	CR Number	H32DT Function Declare
00H	The low byte is the module code, and the high byte is the module version number.		
01H	Communication address		
02H	Communication protocols: The low 4-bit of the low bytes: 0 - N,8,2 For RTU, 1 - E,8,1 For RTU, 2 - O,8,1 For RTU, 3 - N,7,2 For ASCII, 4 - E,7,1 For ASCII, 5 - O,7,1 For ASCII, 6 - N,8, 1 For RTU The high 4-bit of the low bytes: 0 - 2400, 1 - 4800, 2 - 9600, 3 - 19200, 4 - 38400, 5 - 57600, 6 - 115200		
03H~06H	Extend module name		
07H~08H	Default IP address: 192.168.1.111		
09~0AH	Reserve		
0BH	High byte subnet mask (b3~b0, 1 indicates 255, 0 indicates 0, for example, subnet mask 255.255.255.0, b3~b0=1110), low byte reserved		
0CH~0EH	Reserve		
0FH	Error code : 0-normal, 1-illegal firmware identity ,2-incomplete firmware, 3-system data access exception, 4-no external 24V power supply		
10H~13H	Temperature input value of channel 1~4	10H~1FH	Temperature value in 1~16 path of channel 1
14H~17H	Humidity input value of channel 1~4	20H~2FH	Temperature value in 1~16 path of channel 2
18H~1BH	Signal type of channel 1~4 (0-DS18B20 / RW1820 / DS1990, 1-SHT1x / SHT7x)	30H	A/D data bits of channel 1
1CH	The using identification of engineering value	31H	A/D data bits of channel 2
1DH~20H	The data lower-limit of channel 1~4	32H	Temperature disconnection alarm in 1~16 path of channel 1, each bit indicates 1 channel, 0- normal, 1- disconnection.
21H~24H	The data upper-limit of channel 1~4	33H	Temperature disconnection alarm in 1~16 path of channel 2, each bit indicates 1 channel, 0- normal, 1- disconnection.
25H~28H	A/D data bit of channel 1~4	34H	Configuration number of channel 1
29H~2CH	zero point correction of channel 1~4	35H	Configuration number of channel 2.
2DH	Sensor disconnection alarm of channel 1~4, each bit indicates 1 channel, 0- normal, 1- disconnection	36~75H	The serial numbers in 1~16 path of channel 1, each serial number uses 4 registers.
2EH~2FH	Reserve	76~B5H	The serial numbers of 1~16 path of channel 2, each serial number uses 4 registers.
30H~3FH	The serial number of channel 1~4, each serial number uses 4 registers.	B6~C5H	Reserve
40H~4FH	Reserve	C6H	Channel 1 clears the power-off counts in the configuration
		C7H	Channel 2 clears the power-off counts in the configuration

Indicator Declare

CPU Indicator Declare

- POW: power indicator .green, constant light - power normal. Not light - Power abnormal.
- RUN: Running indicator .green, constant light - PLC is running. Not light - PLC is stopping.
- COM: communication indicator .green, flicker - communicating, flicker frequency signify the speed of the communication. Not light - No communication.
- ERR: Error indicator .double(red, yellow), as follows:

Consult Manage	Signify Information Type	ERR The State Of The Indicator
Normal	Without error	Not light
Normal, just prompt take attention to the locked data	PLC have the component which locked	Yellow flicker: On 0.2 seconds and Off 0.8 seconds
Adjust the PLC hardware configure	Problem in the soft setting ,permit user keep on operate the user program	Yellow flicker: On 0.2 seconds and Off 0.8 seconds
Check the parallel bus(check the RTC battery;check expansion module power supply)	Communication abnormal between module, auto dislodge the abnormal module, permit user keep on operate the user program	Yellow flicker: On 0.8 seconds and Off 0.2 seconds
Upgrade the firmware or modify the user program	Firmware abnormal or user program abnormal, cannot operate the user program	Red slowly flicker: On 0.5 seconds and Off 0.5 seconds
Maintain	Hardware error, user program con not running	yellow constant light

Note: For specific error code please check the system register SV3, error code corresponding the content see detail the “system error code table”.

Expansion Modules Indicator Declare

- POW: power indicator green, constant light -Power normal. Not light - Power error.
- LINK: many state indicator .three colors(Red, Yellow, Green), as follow:

Consult Manage	Module Bus State	LINK The State Of The Indicator
Normal	Module no communication	Not light
	MPU identification the module but have not communication	Green constant light
	Serial or parallel communicating	Green flicker: indicator light 30ms not light 30ms
parallel power supply not enough, must connect to external power supply	Without serial or parallel communicate	Yellow flicker: indicator light 0.5s not light0.5s
	With serial or parallel communicate	Yellow dark and shake alternately: indicator not light 0.5s shark 0.5s
Upgrade the firmware fail, re-upgrade the firmware of the module	Without serial or parallel communicate	Red flicker: indicator light 0.5s not light 0.5s
	With serial or parallel communicate	Red dark and shake alternately: indicator not dark 0.5s shark 0.5s
Maintain	Without serial or parallel communicate	Red constant light
	With serial or parallel communicate	Red shark quickly: indicator light 30ms not light 30ms

Note: For specific error code please check the module parameter register CR15, error code corresponding the content see detail the “CR parameter table”.

I/O Indicator Declare

I/O Indicator Type	Indicate Information	The State Of The Indicator
DI	Without signal input	No light
	With signal input	Constant light
	Pulse signal input	Flicker (high frequency often bright)
DO	Without signal output	No light
	With signal output	Constant light
	Pulse signal output	Flicker (high frequency often bright)
AI	Without signal input	No light
	With signal input	Constant light
AO	Without signal output (Channel abnormal)	No light
	With signal output	Constant light

I/O Wiring Diagram

Digital Input (DI) Wiring Diagram

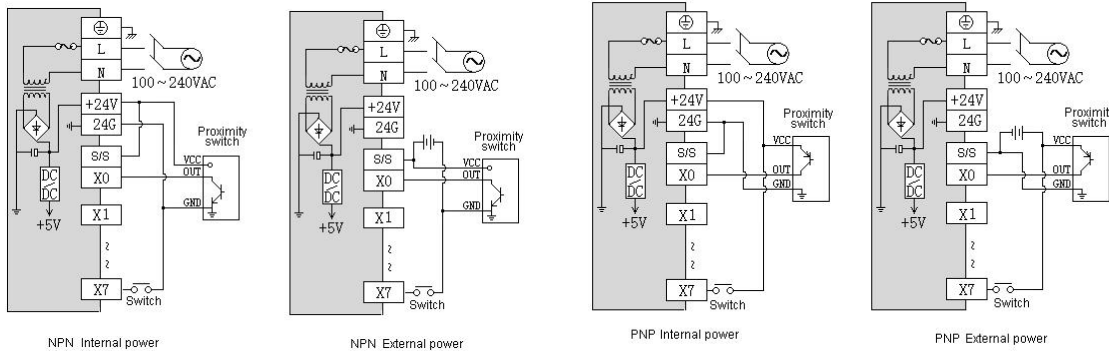

Digital Output (DO) Wiring Diagram

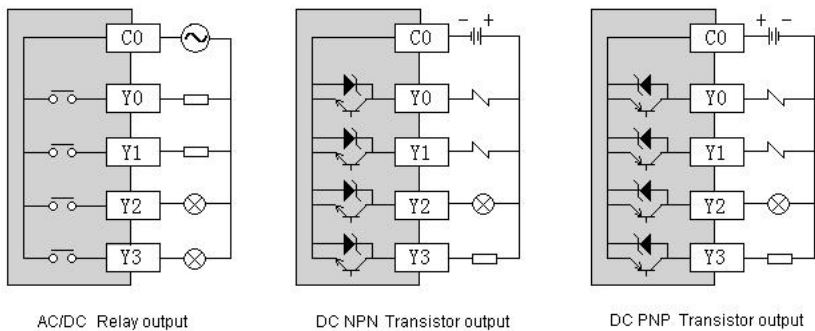

Analog Input (AI) Wiring Diagram

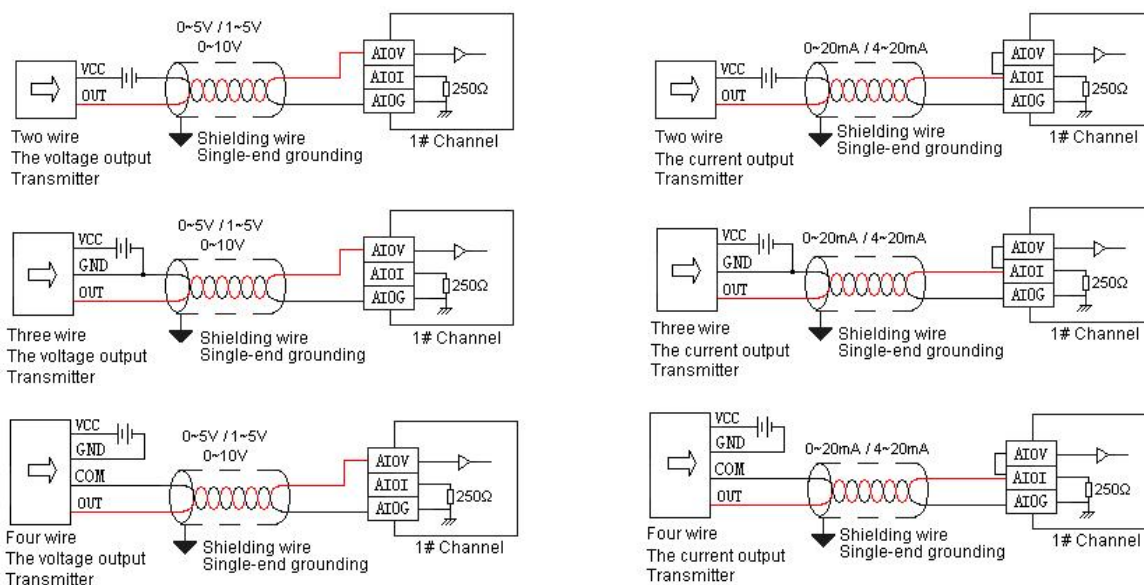

Analog Output (AO) Wiring Diagram

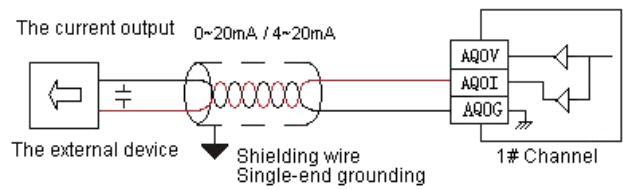
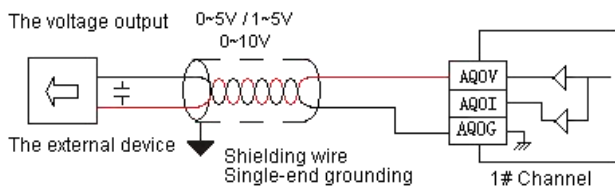

Thermocouple & RTD Input Wiring Diagram

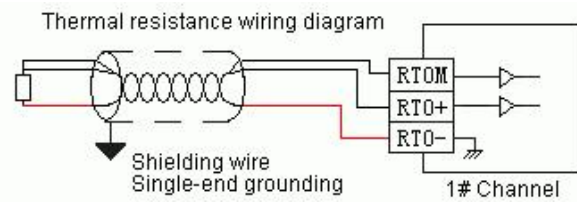
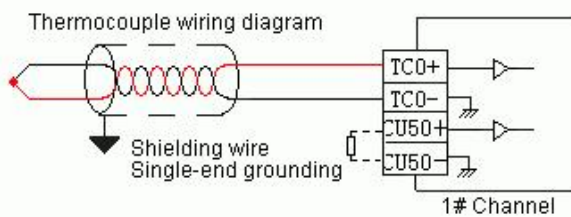

Single or Multiple DS18B20 / RW1820 Sensor Wiring Diagram

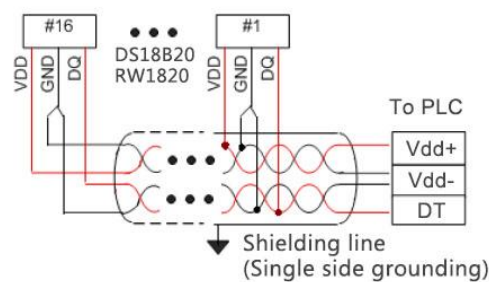
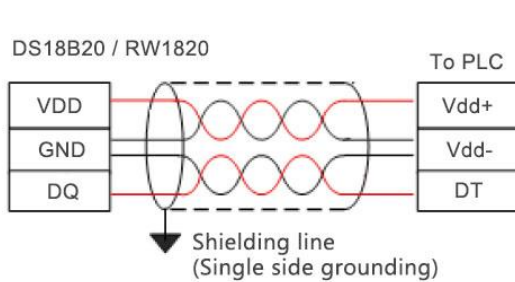

DS1990 Sensor Wiring Diagram

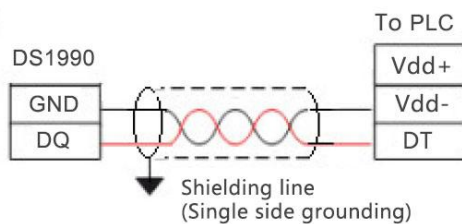

SHT1X / SHT7X Sensor Wiring Diagram

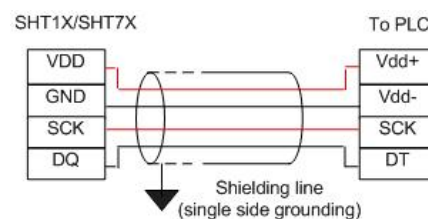

Haiwell PLC Instruction Table

Haiwell PLC have a set of abundance high-efficiency instruction system, depend on absorb instructions of others PLC , support up to 200 application instructions , among there are many powerful innovate easy instructions .as communication instructions (COMM, MODR, MODW, HWRD, HWRW), character conversion instructions (ITOC, CTOI, FTOC, CTOF), data combination disperse instructions (BUNB, BUNW, WUNW, BDIB, WDIB, WDIW), bound alarm instructions(HAL, LAL), valve control instructions(VC), temperature curve(TTC) etc.

Instruction Set Table

Instruction Type	Instruction Name	8bit Model	32bit Model	Instruction Function	Support Language		
					LD	FBD	IL
Compare switch	=	LB.= HB.=	D.=	Equal to compare switch ,have 16 bit/32 bit /low byte/high byte model	√		
	<>	LB.<> HB.<>	D.<>	Unequal to compare switch ,have 16 bit/32 bit /low byte/high byte model	√		
	>	LB.> HB.>	D.>	Greater than compare switch ,have 16 bit/32 bit /low byte/high byte model	√		
	>=	LB.>= HB.>=	D.>=	Great than or equal to compare switch ,have 16 bit/32 bit /low byte/high byte model	√		
	<	LB.< HB.<	D.<	Less than compare switch ,have 16 bit/32 bit /low byte/high byte model	√		
	<=	LB.<= HB.<=	D.<=	Less than or equal to compare switch ,have 16 bit/32 bit /low byte/high byte model	√		
	F.=			Floating-point number equal to compare switch	√		
	F.<>			Floating-point number unequal to compare switch	√		
	F.>			Floating-point number greater than compare switch	√		
	F.>=			Floating-point number greater than or equal to compare switch	√		
	F.<			Floating-point number less than compare switch	√		
	F.<=			Floating-point number less than or equal to compare switch	√		
Step instruction	STL			Step start	√		
	SFROM			Step combine	√		
	STO			Step jump	√		
Bit instruction	AND			Logic AND		√	√
	OR			Logic OR		√	√
	XOR			Logic XOR		√	√
	OUT			Coil output	√	√	√
	SET			Setting	√	√	√
	RST			Reset	√	√	√
	ALT			ON/OFF alternately output	√	√	√
	ZRST			Batch reset	√	√	√

Instruction Type	Instruction Name	8bit Model	32bit Model	Instruction Function	Support Language		
					LD	FBD	IL
	ENO			Get ENO output			√
Timer	TON			Delay ON	√	√	√
	TOF			Delay OFF	√	√	√
	TP			Pulse timer	√	√	√
Counter	CTU		D.CTU	Increase counter	√	√	√
	CTD		D.CTD	Decrease counter	√	√	√
	CTUD		D.CTUD	Increase and Decrease counter	√	√	√
High speed control instruction	RESH			IO refresh	√	√	√
	SHC			Single high speed counter	√	√	√
	HHSC			High speed counter	√	√	√
	HCWR			Write high speed counter	√	√	√
	SPD			Speed detection	√	√	√
	PWM			Pulse width modulation	√	√	√
	PLSY		D.PLSY	Pulse output	√	√	√
	PLSR		D.PLSR	Accelerate and decelerate pulse output	√	√	√
	ZRN			Origin point return	√	√	√
	SETZ			Set electric origin point	√	√	√
	PPMR			Linear interpolation	√	√	√
	CIMR			Circular interpolation	√	√	√
	SPLS			Single pulse output	√	√	√
	MPTO			Multi-segment pulse output	√	√	√
	SYNP			Synchronization pulse output	√	√	√
	PSTOP			Stop pulse output	√	√	√
	DVIT			Interrupt positioning pulse output	√	√	√
	ECAM			The electronic CAM	√	√	√
JOGP			Jog pulse output	√	√	√	
Compare instruction	CMP		D.CMP	Compare instruction	√	√	√
	ZCP		D.ZCP	Regional comparison	√	√	√
	MATC		D.MATC	Numerical match	√	√	√
	ABSC		D.ABSC	Absolute cam comparison	√	√	√
	BON			ON bit determine	√	√	√
	BONC		D.BONC	ON bit numbers	√	√	√
	MAX		D.MAX	Maximum	√	√	√
	MIN		D.MIN	Minimum	√	√	√
	SEL		D.SEL	Selection of conditions	√	√	√
MUX		D.MUX	Multi-choice	√	√	√	
Shift instruction	LBST			Low byte evaluation	√	√	√

Instruction Type	Instruction Name	8bit Model	32bit Model	Instruction Function	Support Language		
					LD	FBD	IL
	HBST			High byte evaluation	√	√	√
	MOV		D.MOV	Move	√	√	√
	BMOV			Block move	√	√	√
	FILL			Fill	√	√	√
	XCH			Byte swap	√	√	√
	BXCH			Block swap	√	√	√
	SHL			Bit left shift	√	√	√
	SHR			Bit right shift	√	√	√
	WSHL			Word left shift	√	√	√
	WSHR			Word right shift	√	√	√
	ROL			Bit rotate left shift	√	√	√
	ROR			Bit rotate right shift	√	√	√
	WROL			Word rotate left shift	√	√	√
	WROR			Word rotate right shift	√	√	√
	BSHL			Byte left shift	√	√	√
	BSHR			Byte right shift	√	√	√
	ATBL			Append to array	√	√	√
	FIFO			First in first out	√	√	√
	LIFO			Last in first out	√	√	√
	SORT			Data sort	√	√	√
Data conversion instruction	ENCO			Encoder	√	√	√
	DECO			Decoder	√	√	√
	BTOW			Bit convert to word	√	√	√
	WTOB			Word convert to bit	√	√	√
	HEX	HEX.LB		ASCII convert to hexadecimal	√	√	√
	ASCI	ASCI.LB		Hexadecimal convert to ASCII	√	√	√
	BUNB			Discrete bit combination to continuous bit	√	√	√
	BUNW			Discrete bit combination to continuous word	√	√	√
	WUNW			Discrete word combination to continuous word	√	√	√
	BDIB			Continuous bit disperse to discrete bit	√	√	√
	WDIB			Continuous word disperse to discrete bit	√	√	√
	WDIW			Continuous word disperse to discrete word	√	√	√
	BCD		D.BCD	BIN convert to BCD	√	√	√
	BIN		D.BIN	BCD convert to BIN	√	√	√
	ITOL			Integer convert to long integer	√	√	√
	GRAY			BIN convert to GRAY code	√	√	√
GBIN			GRAY code convert to BIN	√	√	√	
Character	GHLB			Obtain high low byte	√	√	√

Instruction Type	Instruction Name	8bit Model	32bit Model	Instruction Function	Support Language		
					LD	FBD	IL
instruction	GETB			Capture byte string	√	√	√
	BCMP	BCMP.LB		Byte string comparison	√	√	√
	ITOC		D.ITOC	Integer convert to character	√	√	√
	CTOI			Character convert to integer	√	√	√
	FTOC			Floating point convert to character	√	√	√
	CTOF			Character convert to floating point	√	√	√
Arithmetical instruction	WNOT		D.WNOT	Negation	√	√	√
	WAND		D.WAND	AND operation	√	√	√
	WOR		D.WOR	OR operation	√	√	√
	WXOR		D.WXOR	XOR operation	√	√	√
	ADD		D.ADD	Addition	√	√	√
	SUB		D.SUB	Subtraction	√	√	√
	INC		D.INC	Increase 1	√	√	√
	DEC		D.DEC	Decrease 1	√	√	√
	MUL		D.MUL	Multiplication	√	√	√
	DIV		D.DIV	Division	√	√	√
	ACCU		D.ACCU	Accumulation	√	√	√
	AVG		D.AVG	Average	√	√	√
	ABS		D.ABS	Absolute value	√	√	√
NEG		D.NEG	Two's complement	√	√	√	
Floating point instruction	FCMP			Floating point comparison	√	√	√
	FZCP			Floating point regional comparison	√	√	√
	FMOV			Floating point move instruction	√	√	√
	FADD			Floating point addition	√	√	√
	FSUB			Floating point subtraction	√	√	√
	FMUL			Floating point multiplication	√	√	√
	FDIV			Floating point division	√	√	√
	FACCU			Floating point accumulation	√	√	√
	FAVG			Floating point average	√	√	√
	FMAX			Floating point maximum	√	√	√
	FMIN			Floating point minimum	√	√	√
	FTOI			Floating point convert to integer	√	√	√
	ITOF		D.ITOF	Integer convert to floating point	√	√	√
	FABS			Floating point absolute	√	√	√
	FSQR			Floating point square root	√	√	√
	FSIN			Sine	√	√	√
	FCOS			Cosine	√	√	√
FTAN			Tangent	√	√	√	

Instruction Type	Instruction Name	8bit Model	32bit Model	Instruction Function	Support Language		
					LD	FBD	IL
	FASIN			Arcsine	√	√	√
	FACOS			Arccosine	√	√	√
	FATAN			Arctangent	√	√	√
	FLN			Natural logarithm	√	√	√
	FLOG			The base-10 logarithm of a number	√	√	√
	FEXP			Nature exponential	√	√	√
	FRAD			Angle convert to radian	√	√	√
	FDEG			Radian convert to angle	√	√	√
	FXY			Exponent	√	√	√
Clock instruction	TCMP			Real time clock comparison	√	√	√
	TACCU			Time accumulative total	√	√	√
	SCLK			Setup system clock	√	√	√
	TIME			Time switch	√	√	√
	DATE			Date switch	√	√	√
	INVT			Count down	√	√	√
Communication instruction	SUM	SUM.LB		SUM verify	√	√	√
	BCC	BCC.LB		BCC verify	√	√	√
	CRC	CRC.LB		CRC verify	√	√	√
	LRC	LRC.LB		LRC verify	√	√	√
	COMM	COMM.LB		Serial communications	√	√	√
	MODR			Modbus read	√	√	√
	MODW			Modbus write	√	√	√
	HWRD			Haiwellbus read	√	√	√
	HWWR			Haiwellbus write	√	√	√
	RCV			Receive communication data	√	√	√
	XMT	XMT.LB		Sent communication data	√	√	√
	FROM			expansion module CR register read	√	√	√
	TO			expansion module CR register write	√	√	√
	TCPMDR			Modbus TCP read	√	√	√
	TCPMDW			Modbus TCP write	√	√	√
TCPHWR			Haiwellbus TCP read	√	√	√	
TCPHWW			Haiwellbus TCP write	√	√	√	
Interrupt instruction	ATCH			Interrupt binding	√	√	√
	DTCH			Interrupt release	√	√	√
	ENI			Enable interrupt	√	√	√
	DISI			Disable interrupt	√	√	√
Program control	MC			Master control	√	√	√

Instruction Type	Instruction Name	8bit Model	32bit Model	Instruction Function	Support Language		
					LD	FBD	IL
instruction	MCR			Master control clear	√	√	√
	FOR			Loop command	√	√	√
	NEXT			Loop end	√	√	√
	WAIT			Delay wait	√	√	√
	CALL			Call subroutine	√	√	√
	EXIT			Condition exit	√	√	√
	REWD			Scanning time reset	√	√	√
	JMPC			Condition jump	√	√	√
	LBL			Jump label	√	√	√
Special function instruction	GPWM			General pulse width modulation	√	√	√
	FTC			Fuzzy temperature control	√	√	√
	PID			PID control	√	√	√
	HAL		D.HAL	Upper limit alarm	√	√	√
	LAL		D.LAL	Lower limit alarm	√	√	√
	LIM		D.LIM	Range limitation	√	√	√
	SC		D.SC	Linear conversion	√	√	√
	VC			Valve control	√	√	√
	TTC			Temperature curve control	√	√	√
	APID			Self-tuning PID	√	√	√

General Declare of the Instruction

- En enable input: En is the enable input item of the instruction. Only En have electricity (ON), the instruction executed, otherwise not executed.
- Eno Enable output: Eno is the Enable output item of the instruction, indicate the instruction is executing. When En have electricity (ON) and instruction executed properly then Eno output have electricity (ON), when En have not electricity (OFF) or instruction executed error (e.g: parameter not property of the instruction) then Eno output have not electricity (OFF). The application instruction in LD, FBD language ,the great mass of the instruction have Eno Enable output item, All IL instructions have not Eno output item, it will be instead of the ENO instruction in IL language.
- In LD language the AND, OR, XOR instructions, will be instead of logic link.
- 32 bit instruction at 16 bit instruction name "D.", indicate use 2 continuous register. Such as ADD,16 bit addition is ADD,32 bit addition is D.ADD.
- 8 bit instruction at 16 bit instruction behind the name plus ".LB", indicate only use the low byte of the register. Such as COMM, 16 bit instruction is COMM, 8 bit instruction is COMM.LB.
- When the parameter items of many instruction which autoOccupy several continuous register, pay special attention to them when programming, avoid reusing the register to program execution incorrect.

Note:

Except CV48~CV79 are 32 bit register (total 32 entries), Haiwell PLC other registers (AI, AQ, V, SV, LV, TV, CV, P) all are 16 bit register, one 16 bit register have 2 byte compose, one 32 bit register have 2 continuous 16 bit registers compose.

SM System Status Bit

SM system status bit is a group of special internal relay of the system, can be used unlimited in the program, each SM has a special function. Do not use the SM which unlisted.

SM	Function Declare	R/W	Power-Off Preserve	Default
SM0	On during running, Off during stopping	R	No	0
SM1	Off during running, On during stopping	R	No	0
SM2	On during the first scan when PLC starts RUN and then be Off	R	No	0
SM3	10ms clock pulse	R	No	0
SM4	100ms clock pulse	R	No	0
SM5	1s clock pulse	R	No	0
SM8	Scan time-out	R	No	0
SM9	PLC switch status	R	No	0
SM10	Run status	R	No	0
SM11	System failure	R	No	0
SM12	Hardware configure table mismatch the module	R	No	0
SM13	Battery in low voltage, malfunction or no battery	R	No	0
SM14	Divide by zero flag	R	No	0
SM15	Data overflow flag	R	No	0
SM16	COM1 communicate error	R	No	0
SM17	COM2 communicate error	R	No	0
SM18	COM3 communicate error	R	No	0
SM19	COM4 communicate error	R	No	0
SM20	COM5 communicate error	R	No	0
SM25	HSC0 study mode control, 0-Normal mode 1-study mode	R/W	No	0
SM26	HSC0 confirm the study control	R/W	No	0
SM27	HSC0 reset control 0 is automatic reset 1 is not reset	R/W	No	0
SM30	HSC0 direction 0-Addition 1-Subtract	R	No	0
SM31	HSC0 error	R	No	0
SM33	HSC1 study mode control, 0-Normal mode 1-study mode	R/W	No	0
SM34	HSC1 confirm the study control	R/W	No	0
SM35	HSC1 reset control 0 is automatic reset 1 is not reset	R/W	No	0
SM38	HSC1 direction 0-Addition 1-Subtract	R	No	0
SM39	HSC1 error	R	No	0
SM41	HSC2 study mode control, 0-Normal mode 1-study mode	R/W	No	0
SM42	HSC2 confirm the study control	R/W	No	0
SM43	HSC2 reset control 0 is automatic reset 1 is not reset	R/W	No	0
SM46	HSC2 direction 0-Addition 1-Subtract	R	No	0
SM47	HSC2 error	R	No	0
SM49	HSC3 study mode control, 0-Normal mode 1-study mode	R/W	No	0
SM50	HSC3 confirm the study control	R/W	No	0
SM51	HSC3 reset control 0 is automatic reset 1 is not reset	R/W	No	0
SM54	HSC3 direction 0-Addition 1-Subtract	R	No	0
SM55	HSC3 error	R	No	0
SM57	HSC4 study mode control, 0-Normal mode 1-study mode	R/W	No	0
SM58	HSC4 confirm the study control	R/W	No	0
SM59	HSC4 reset control 0 is automatic reset 1 is not reset	R/W	No	0
SM62	HSC4 direction 0-Addition 1-Subtract	R	No	0

SM63	HSC4 error	R	No	0
SM65	HSC5 study mode control, 0-Normal mode 1-study mode	R/W	No	0
SM66	HSC5 confirm the study control	R/W	No	0
SM67	HSC5 reset control 0 is automatic reset 1 is not reset	R/W	No	0
SM70	HSC5 direction 0-Addition 1-Subtract	R	No	0
SM71	HSC5 error	R	No	0
SM73	HSC6 study mode control, 0-Normal mode 1-study mode	R/W	No	0
SM74	HSC6 confirm the study control	R/W	No	0
SM75	HSC6 reset control 0 is automatic reset 1 is not reset	R/W	No	0
SM78	HSC6 direction 0-Addition 1-Subtract	R	No	0
SM79	HSC6 error	R	No	0
SM81	HSC7 study mode control, 0-Normal mode 1-study mode	R/W	No	0
SM82	HSC7 confirm the study control	R/W	No	0
SM83	HSC7 reset control 0 is automatic reset 1 is not reset	R/W	No	0
SM86	HSC7 direction 0-Addition 1-Subtract	R	No	0
SM87	HSC7 error	R	No	0
SM93	PLS0 prohibit the forward pulse	R/W	yes	0
SM94	PLS0 prohibit the reverse pulse	R/W	yes	0
SM95	PLS0 prohibit the brake function	R/W	yes	0
SM96	PLS0 pulse output flag	R	yes	0
SM97	PLS0 pulse output direction flag 0-forward 1-Reverse	R	yes	0
SM98	PLS0 error flag	R	yes	0
SM99	PLS0 position mode 0-relatively mode 1-absolutely mode	R/W	yes	0
SM100	PLS0 output when position complete	R	yes	0
SM109	PLS1 prohibit the forward pulse	R/W	yes	0
SM110	PLS1 prohibit the reverse pulse	R/W	yes	0
SM111	PLS1 prohibit the brake function	R/W	yes	0
SM112	PLS1 pulse output flag	R	yes	0
SM113	PLS1 pulse output direction flag 0-forward 1-Reverse	R	yes	0
SM114	PLS1 error flag	R	yes	0
SM115	PLS1 position mode 0-relatively mode 1-absolutely mode	R/W	yes	0
SM116	PLS1 output when position complete	R	yes	0
SM125	PLS2 prohibit the forward pulse	R/W	yes	0
SM126	PLS2 prohibit the reverse pulse	R/W	yes	0
SM127	PLS2 prohibit the brake function	R/W	yes	0
SM128	PLS2 pulse output flag	R	yes	0
SM129	PLS2 pulse output direction flag 0-forward 1-Reverse	R	yes	0
SM130	PLS2 error flag	R	yes	0
SM131	PLS2 position mode 0-relatively mode 1-absolutely mode	R/W	yes	0
SM132	PLS2 output when position complete	R	yes	0
SM141	PLS3 prohibit the forward pulse	R/W	yes	0
SM142	PLS3 prohibit the reverse pulse	R/W	yes	0
SM143	PLS3 prohibit the brake function	R/W	yes	0
SM144	PLS3 pulse output flag	R	yes	0
SM145	PLS3 pulse output direction flag 0-forward 1-Reverse	R	yes	0
SM146	PLS3 error flag	R	yes	0
SM147	PLS3 position mode 0-relatively mode 1-absolutely mode	R/W	yes	0

SM148	PLS3 output when position complete	R	yes	0
SM157	PLS4 prohibit the forward pulse	R/W	yes	0
SM158	PLS4 prohibit the reverse pulse	R/W	yes	0
SM159	PLS4 prohibit the brake function	R/W	yes	0
SM160	PLS4 pulse output flag	R	yes	0
SM161	PLS4 pulse output direction flag 0-forward 1-Reverse	R	yes	0
SM162	PLS4 error flag	R	yes	0
SM163	PLS4 position mode 0-relatively mode 1-absolutely mode	R/W	yes	0
SM164	PLS4 output when position complete	R	yes	0
SM173	PLS5 prohibit the forward pulse	R/W	yes	0
SM174	PLS5 prohibit the reverse pulse	R/W	yes	0
SM175	PLS5 prohibit the brake function	R/W	yes	0
SM176	PLS5 pulse output flag	R	yes	0
SM177	PLS5 pulse output direction flag 0-forward 1-Reverse	R	yes	0
SM178	PLS5 error flag	R	yes	0
SM179	PLS5 position mode 0-relatively mode 1-absolutely mode	R/W	yes	0
SM180	PLS5 output when position complete	R	yes	0
SM189	PLS6 prohibit the forward pulse	R/W	yes	0
SM190	PLS6 prohibit the reverse pulse	R/W	yes	0
SM191	PLS6 prohibit the brake function	R/W	yes	0
SM192	PLS6 pulse output flag	R	yes	0
SM193	PLS6 pulse output direction flag 0-forward 1-Reverse	R	yes	0
SM194	PLS6 error flag	R	yes	0
SM195	PLS6 position mode 0-relatively mode 1-absolutely mode	R/W	yes	0
SM196	PLS6 output when position complete	R	yes	0
SM205	PLS7 prohibit the forward pulse	R/W	yes	0
SM206	PLS7 prohibit the reverse pulse	R/W	yes	0
SM207	PLS7 prohibit the brake function	R/W	yes	0
SM208	PLS7 pulse output flag	R	yes	0
SM209	PLS7 pulse output direction flag 0-forward 1-Reverse	R	yes	0
SM210	PLS7 error flag	R	yes	0
SM211	PLS7 position mode 0-relatively mode 1-absolutely mode	R/W	yes	0
SM212	PLS7 output when position complete	R	yes	0

SV System Register

SV system register is a group of special internal register of the system, can be used unlimited in the program, each SV has a special function. Do not use the SM which unlisted.

SV	Function Declare	R/W	Power-Off Preserve	Default
SV0	The present scan time(unit 0.1ms)	R	No	0
SV1	The minimum scan time(unit 0.1ms)	R	No	0
SV2	The maximum scan time(unit 0.1ms)	R	No	0
SV3	System fault code, detail see the system fault code table	R	No	0
SV4	COM1 communicate error code	R	No	0
SV5	COM2 communicate error code	R	No	0
SV6	COM3 communicate error code	R	No	0
SV7	COM4 communicate error code	R	No	0
SV8	COM5 communicate error code	R	No	0
SV9	Modbus TCP client port setting, server port fixed as 502	R	No	0
SV11	AI input on the CPU module break off alarm every bit express one channel 0-Normal 1-break off	R	No	0
SV12	Year	R	No	0
SV13	Month(1-12)	R	No	0
SV14	Day(1-31)	R	No	0
SV15	Hour(0-23)	R	No	0
SV16	Minute(0-59)	R	No	0
SV17	Second(0-59)	R	No	0
SV18	Week(1-7,Monday~Sunday)	R	No	0
SV19	PLC station's name	R/W	yes	0
SV20	PLC station's name	R/W	yes	0
SV21	PLC station's name	R/W	yes	0
SV22	PLC station's name	R/W	yes	0
SV23	PLC station's name	R/W	yes	0
SV24	PLC station's name	R/W	yes	0
SV25	Timer of program scan time-out(unit ms)	R/W	yes	200 ms
SV26	PLC address 1~254	R	yes	1
SV27	Low byte is expansion modules 0~31 High byte is type	R	yes	0
SV28	Low byte is CPU's type High byte is CPU's version	R	yes	0
SV29	Low byte is first expansion module's code High byte is first expansion module's version	R	yes	0
SV30	Low byte is second expansion module's code High byte is second expansion module's version	R	yes	0
SV31	Low byte is third expansion module's code High byte is third expansion module's version	R	yes	0
SV32	Low byte is fourth expansion module's code High byte is fourth expansion module's version	R	yes	0

SV33	Low byte is fifth expansion module's code High byte is fifth expansion module's version	R	yes	0
SV34	Low byte is sixth expansion module's code High byte is sixth expansion module's version	R	yes	0
SV35	Low byte is seventh expansion module's code High byte is seventh expansion module's version	R	yes	0
SV36	Low byte is eighth expansion module's code High byte is eighth expansion module's version	R	yes	0
SV37	Low byte is ninth expansion module's code High byte is ninth expansion module's version	R	yes	0
SV38	Low byte is tenth expansion module's code High byte is tenth expansion module's version	R	yes	0
SV39	Low byte is eleventh expansion module's code High byte is eleventh expansion module's version	R	yes	0
SV40	Low byte is twelfth expansion module's code High byte is twelfth expansion module's version	R	yes	0
SV41	Low byte is thirteenth expansion module's code High byte is thirteenth expansion module's version	R	yes	0
SV42	Low byte is fourteenth expansion module's code High byte is fourteenth expansion module's version	R	yes	0
SV43	Low byte is fifteenth expansion module's code High byte is fifteenth expansion module's version	R	yes	0
SV44	COM1 communicate protocol: Low 4 bit of low byte: 0 - N,8, 2 For RTU 1 - E,8, 1 For RTU 2 - O 8, ,1 For RTU 3 - N,7, 2 For ASCII 4 - E,7, 1 For ASCII 5 - O,7, 1 For ASCII 6 - N,8, 1 For RTU(H/N serial support) High 4 bit of low byte: 0 - 2400 1 - 4800 2 - 9600 3 - 19200 4 - 38400 5 - 57600 6 - 115200(H/N serial support)	R/W	yes	30H,19200, N,8, 2 RTU
SV45	COM1 and Ethernet communicate overtime ,unit ms	R/W	yes	200ms
SV46	COM2 communicate protocol, the same as COM1	R/W	yes	30H
SV47	COM2 communicate overtime ,unit ms	R/W	yes	200ms
SV48	PLC program size	R	yes	0
SV49	Low byte of system clock ,unit 16μs	R	yes	
SV50	High byte of system clock ,unit 16μs	R	yes	
SV54	COM3 communicate protocol, the same as COM1	R/W	yes	30H
SV55	COM3 communicate overtime ,unit ms	R/W	yes	200ms
SV56	COM4 communicate protocol, the same as COM1	R/W	yes	30H
SV57	COM4 communicate overtime ,unit ms	R/W	yes	200ms
SV58	COM5 communicate protocol, the same as COM1	R/W	yes	30H
SV59	COM5 communicate overtime ,unit ms	R/W	yes	200ms
SV60	HSC0 current segment number	R	yes	0
SV61	HSC0 low word of current value	R	yes	0
SV62	HSC0 high word of current value	R	yes	0
SV63	HSC0 error code	R	yes	0
SV64	HSC1 current segment number	R	yes	0

SV65	HSC1 low word of current value	R	yes	0
SV66	HSC1 high word of current value	R	yes	0
SV67	HSC1 error code	R	yes	0
SV68	HSC2 current segment number	R	yes	0
SV69	HSC2 low word of current value	R	yes	0
SV70	HSC2 high word of current value	R	yes	0
SV71	HSC2 error code	R	yes	0
SV72	HSC3 current segment number	R	yes	0
SV73	HSC3 low word of current value	R	yes	0
SV74	HSC3 high word of current value	R	yes	0
SV75	HSC3 error code	R	yes	0
SV76	HSC4 current segment number	R	yes	0
SV77	HSC4 low word of current value	R	yes	0
SV78	HSC4 high word of current value	R	yes	0
SV79	HSC4 error code	R	yes	0
SV80	HSC5 current segment number	R	yes	0
SV81	HSC5 low word of current value	R	yes	0
SV82	HSC5 high word of current value	R	yes	0
SV83	HSC5 error code	R	yes	0
SV84	HSC6 current segment number	R	yes	0
SV85	HSC6 low word of current value	R	yes	0
SV86	HSC6 high word of current value	R	yes	0
SV87	HSC6 error code	R	yes	0
SV88	HSC7 current segment number	R	yes	0
SV89	HSC7 low word of current value	R	yes	0
SV90	HSC7 high word of current value	R	yes	0
SV91	HSC7 error code	R	yes	0
SV92	PLS0 current segment number	R	yes	0
SV93	PLS0 low word of pulse output number	R	yes	0
SV94	PLS0 high word of pulse output number	R	yes	0
SV95	PLS0 low word of current position	R	yes	0
SV96	PLS0 high word of current position	R	yes	0
SV97	PLS0 error code	R	yes	0
SV98	PLS1 current segment number	R	yes	0
SV99	PLS1 low word of pulse output number	R	yes	0
SV100	PLS1 high word of pulse output number	R	yes	0
SV101	PLS1 low word of current position	R	yes	0
SV102	PLS1 high word of current position	R	yes	0
SV103	PLS1 error code	R	yes	0
SV104	PLS2 current segment number	R	yes	0

SV105	PLS2 low word of pulse output number	R	yes	0
SV106	PLS2 high word of pulse output number	R	yes	0
SV107	PLS2 low word of current position	R	yes	0
SV108	PLS2 high word of current position	R	yes	0
SV109	PLS2 error code	R	yes	0
SV110	PLS3 current segment number	R	yes	0
SV111	PLS3 low word of pulse output number	R	yes	0
SV112	PLS3 high word of pulse output number	R	yes	0
SV113	PLS3 low word of current position	R	yes	0
SV114	PLS3 high word of current position	R	yes	0
SV115	PLS3 error code	R	yes	0
SV116	PLS4 current segment number	R	yes	0
SV117	PLS4 low word of pulse output number	R	yes	0
SV118	PLS4 high word of pulse output number	R	yes	0
SV119	PLS4 low word of current position	R	yes	0
SV120	PLS4 high word of current position	R	yes	0
SV121	PLS4 error code	R	yes	0
SV122	PLS5 current segment number	R	yes	0
SV123	PLS5 low word of pulse output number	R	yes	0
SV124	PLS5 high word of pulse output number	R	yes	0
SV125	PLS5 low word of current position	R	yes	0
SV126	PLS5 high word of current position	R	yes	0
SV127	PLS5 error code	R	yes	0
SV128	PLS6 current segment number	R	yes	0
SV129	PLS6 low word of pulse output number	R	yes	0
SV130	PLS6 high word of pulse output number	R	yes	0
SV131	PLS6 low word of current position	R	yes	0
SV132	PLS6 high word of current position	R	yes	0
SV133	PLS6 error code	R	yes	0
SV134	PLS7 current segment number	R	yes	0
SV135	PLS7 low word of pulse output number	R	yes	0
SV136	PLS7 high word of pulse output number	R	yes	0
SV137	PLS7 low word of current position	R	yes	0
SV138	PLS7 high word of current position	R	yes	0
SV139	PLS7 error code	R	yes	0
SV140	When value is -23206 prohibit all output of Y	R/W	yes	0
SV141	COM1 communicate instruction execute interval unit ms	R/W	yes	0
SV142	The soft address of PLC(1~254)	R	yes	0
SV143	The setted address of the external DIP switch	R	yes	0
SV144	Low word of serial number	R	yes	0

SV145	High word of serial number	R	yes	0
SV146	Time of the direction output before the pulse output(5~100us)	R/W	yes	5
SV151	Number of locked data	R	yes	0
SV152	IP address,default: 192.168.1.111	R/W	yes	0x0058
SV153	IP address,default: 192.168.1.111	R/W	yes	0xC0A8
SV154	Subnet mask,default: 255.255.255.0	R/W	yes	0xFF00
SV155	Subnet mask,default: 255.255.255.0	R/W	yes	0xFFFF
SV156	PLS0 low word of mechanical original point	R/W	yes	0
SV157	PLS0 high word of mechanical original point	R/W	yes	0
SV158	PLS0 number of pulses to compensate the reverse interval	R/W	yes	0
SV159	PLS0 follow performance parameters,range: 1~100	R/W	yes	50
SV160	PLS1 low word of mechanical original point	R/W	yes	0
SV161	PLS1 high word of mechanical original point	R/W	yes	0
SV162	PLS1 number of pulses to compensate the reverse interval	R/W	yes	0
SV163	PLS1 follow performance parameters,range: 1~100	R/W	yes	50
SV164	PLS2 low word of mechanical original point	R/W	yes	0
SV165	PLS2 high word of mechanical original point	R/W	yes	0
SV166	PLS2 number of pulses to compensate the reverse interval	R/W	yes	0
SV167	PLS2 follow performance parameters,range: 1~100	R/W	yes	50
SV168	PLS3 low word of mechanical original point	R/W	yes	0
SV169	PLS3 high word of mechanical original point	R/W	yes	0
SV170	PLS3 number of pulses to compensate the reverse interval	R/W	yes	0
SV171	PLS3 follow performance parameters,range: 1~100	R/W	yes	50
SV172	PLS4 low word of mechanical original point	R/W	yes	0
SV173	PLS4 high word of mechanical original point	R/W	yes	0
SV174	PLS4 number of pulses to compensate the reverse interval	R/W	yes	0
SV175	PLS4 follow performance parameters,range: 1~100	R/W	yes	50
SV176	PLS5 low word of mechanical original point	R/W	yes	0
SV177	PLS5 high word of mechanical original point	R/W	yes	0
SV178	PLS5 number of pulses to compensate the reverse interval	R/W	yes	0
SV179	PLS5 follow performance parameters,range: 1~100	R/W	yes	50
SV180	PLS6 low word of mechanical original point	R/W	yes	0
SV181	PLS6 high word of mechanical original point	R/W	yes	0
SV182	PLS6 number of pulses to compensate the reverse interval	R/W	yes	0
SV183	PLS6 follow performance parameters,range: 1~100	R/W	yes	50
SV184	PLS7 low word of mechanical original point	R/W	yes	0
SV185	PLS7 high word of mechanical original point	R/W	yes	0
SV186	PLS7 number of pulses to compensate the reverse interval	R/W	yes	0
SV187	PLS7 follow performance parameters,range: 1~100	R/W	yes	50
SV801	HSC0 low word of frequency	R	yes	0

SV802	HSC0 high word of frequency	R	yes	0
SV803	HSC1 low word of frequency	R	yes	0
SV804	HSC1 high word of frequency	R	yes	0
SV805	HSC2 low word of frequency	R	yes	0
SV806	HSC2 high word of frequency	R	yes	0
SV807	HSC3 low word of frequency	R	yes	0
SV808	HSC3 high word of frequency	R	yes	0
SV809	HSC4 low word of frequency	R	yes	0
SV810	HSC4 high word of frequency	R	yes	0
SV811	HSC5 low word of frequency	R	yes	0
SV812	HSC5 high word of frequency	R	yes	0
SV813	HSC6 low word of frequency	R	yes	0
SV814	HSC6 high word of frequency	R	yes	0
SV815	HSC7 low word of frequency	R	yes	0
SV816	HSC7 high word of frequency	R	yes	0
SV817	Historical fault code	R	yes	0
SV818	Historical fault code	R	yes	0
SV819	Historical fault code	R	yes	0
SV820	Historical fault code	R	yes	0
SV821	Historical fault code	R	yes	0
SV822	Historical fault code	R	yes	0
SV823	Historical fault code	R	yes	0
SV824	Historical fault code	R	yes	0
SV825	Historical fault code	R	yes	0
SV826	Historical fault code	R	yes	0
SV827	Historical fault code	R	yes	0
SV828	Historical fault code	R	yes	0
SV829	Historical fault code	R	yes	0
SV830	Historical fault code	R	yes	0
SV831	Historical fault code	R	yes	0
SV832	Historical fault code	R	yes	0
SV833	COM2 Communicate instruction execute interval unit ms	R/W	yes	0
SV834	COM3 Communicate instruction execute interval unit ms	R/W	yes	0
SV835	COM4 Communicate instruction execute interval unit ms	R/W	yes	0
SV836	COM5 Communicate instruction execute interval unit ms	R/W	yes	0
SV840	System status error code	R	yes	0
SV841	System status error code	R	yes	0
SV842	CPU firmware version date (low byte for year, high byte for month)	R	yes	0
SV843	CPU firmware version date (low byte for day, high byte for hour)	R	yes	0
SV844	FGPA firmware version date (low byte for year, high byte for month)	R	yes	0

SV845	FGPA firmware version date (low byte for day, high byte for hour)	R	yes	0
SV846	Gateway address:(default:192.168.1.1)	R/W	yes	0x0101
SV847	Gateway address:(default:192.168.1.1)	R/W	yes	0xC0A8
SV848	MAC address	R	yes	0
SV849	MAC address	R	yes	0
SV850	MAC address	R	yes	0
SV851	COM1 Communication port timeout exception in receiving characters(in milliseconds)	R/W	yes	0
SV852	COM2 Communication port timeout exception in receiving characters(in milliseconds)	R/W	yes	0
SV853	COM3 Communication port timeout exception in receiving characters(in milliseconds)	R/W	yes	0
SV854	COM4 Communication port timeout exception in receiving characters(in milliseconds)	R/W	yes	0
SV855	COM5 Communication port timeout exception in receiving characters(in milliseconds)	R/W	yes	0

System Interruption Table

Haiwell PLC support 52 system interruption, include pulse output, edge catch, high speed counter and timed interruption.

Interruption No.	Interruption Type	Declare	Priority Level
1	Pulse output interruption	PLS0 pulse output start	High to low (the small interruption no. priority the big interruption no.)
2		PLS0 pulse output complete	
3		PLS1 pulse output start	
4		PLS1 pulse output complete	
5		PLS2 pulse output start	
6		PLS2 pulse output complete	
7		PLS3 pulse output start	
8		PLS3 pulse output complete	
9		PLS4 pulse output start	
10		PLS4 pulse output complete	
11		PLS5 pulse output start	
12		PLS5 pulse output complete	
13		PLS6 pulse output start	
14		PLS6 pulse output complete	
15		PLS7 pulse output start	
16		PLS7 pulse output complete	
17	Edge catch interruption	X0 rise edge catch	
18		X1 rise edge catch	
19		X2 rise edge catch	
20		X3 rise edge catch	
21		X4 rise edge catch	
22		X5 rise edge catch	
23		X6 rise edge catch	
24		X7 rise edge catch	
25		X0 drop edge catch	
26		X1 drop edge catch	
27		X2 drop edge catch	
28		X3 drop edge catch	
29		X4 drop edge catch	
30		X5 drop edge catch	
31		X6 drop edge catch	
32		X7 drop edge catch	
33	High speed counter interruption	HSC0 current value=preset value(each segment preset be generated)	
34		HSC0 input direction changed	
35		HSC1 current value=preset value(each segment preset be generated)	
36		HSC1 input direction changed	
37		HSC2 current value=preset value(each segment preset be generated)	
38		HSC2 input direction changed	
39		HSC3 current value=preset value(each segment preset be generated)	
40		HSC3 input direction changed	

Interruption No.	Interruption Type	Declare	Priority Level	
41		HSC4 current value=preset value(each segment preset be generated)		
42		HSC4 input direction changed		
43		HSC5 current value=preset value(each segment preset be generated)		
44		HSC5 input direction changed		
45		HSC6 current value=preset value(each segment preset be generated)		
46		HSC6 input direction changed		
47		HSC7 current value=preset value(each segment preset be generated)		
48		HSC7 input direction changed		
49		Timed interruption		T252 timer reaches target
50				T253 timer reaches target
51				T254 timer reaches target
52				T255 timer reaches target

Error Code Table

Error Category	Description
A	Hardware failure, user program not runnable , needs to return to factory repair , red indicator light keeps on
B	Firmware exception or user program exception, user program not runnable , red indicator light will be on 0.5 seconds and be off 0.5 seconds
C	Communication exception between the modules, automatically remove the module with exception, yellow indicator light will be on 0.8 seconds and be off 0.2 seconds
D	Incorrect software setup, allow the user program to continue, yellow indicator light will be on 0.2 seconds and be off 0.8 seconds

Error Code	Message Indicated	Error Category	Indicator color	Indicator effect
0	System normal			
1	CPU firmware incomplete	B	Red	On 0.5 seconds and Off 0.5 seconds
2	CPU memory 1 access error	A	Red	Keep on
3	CPU memory 2 access error	A	Red	Keep on
4	RTC access error	A	Red	Keep on
5	CPU I/O access Error	A	Red	Keep on
6	CPU memory 3 access error	A	Red	Keep on
7	I/O board access error	A	Red	Keep on
8	Enhanced bus work abnormal	A	Red	Keep on
59	Slave CPU firmware incomplete	B	Red	On 0.5 seconds and Off 0.5 seconds
60	1# expansion module firmware incomplete	B	Red	On 0.5 seconds and Off 0.5 seconds
61	2# expansion module firmware incomplete	B	Red	On 0.5 seconds and Off 0.5 seconds
62	3# expansion module firmware incomplete	B	Red	On 0.5 seconds and Off 0.5 seconds
63	4# expansion module firmware incomplete	B	Red	On 0.5 seconds and Off 0.5 seconds
64	5# expansion module firmware incomplete	B	Red	On 0.5 seconds and Off 0.5 seconds
65	6# expansion module firmware incomplete	B	Red	On 0.5 seconds and Off 0.5 seconds
66	7# expansion module firmware incomplete	B	Red	On 0.5 seconds and Off 0.5 seconds
67	8# expansion module firmware incomplete	B	Red	On 0.5 seconds and Off 0.5 seconds
68	9# expansion module firmware incomplete	B	Red	On 0.5 seconds and Off 0.5 seconds
69	10# expansion module firmware incomplete	B	Red	On 0.5 seconds and Off 0.5 seconds
70	11# expansion module firmware incomplete	B	Red	On 0.5 seconds and Off 0.5 seconds
71	12# expansion module firmware incomplete	B	Red	On 0.5 seconds and Off 0.5 seconds
72	13# expansion module firmware incomplete	B	Red	On 0.5 seconds and Off 0.5 seconds
73	14# expansion module firmware incomplete	B	Red	On 0.5 seconds and Off 0.5 seconds
74	15# expansion module firmware incomplete	B	Red	On 0.5 seconds and Off 0.5 seconds
75	expansion module hardware failure	B	Red	On 0.5 seconds and Off 0.5 seconds
87	Illegal table content	B	Red	On 0.5 seconds and Off 0.5 seconds

Error Code	Message Indicated	Error Category	Indicator color	Indicator effect
88	Out of program stack space	B	Red	On 0.5 seconds and Off 0.5 seconds
89	Programming software version is too low	B	Red	On 0.5 seconds and Off 0.5 seconds
90	User program corrupted	B	Red	On 0.5 seconds and Off 0.5 seconds
91	Step component exceed range	B	Red	On 0.5 seconds and Off 0.5 seconds
92	Step combine exceed range	B	Red	On 0.5 seconds and Off 0.5 seconds
93	The table record number is beyond range	B	Red	On 0.5 seconds and Off 0.5 seconds
94	Catch edge times exceed range	B	Red	On 0.5 seconds and Off 0.5 seconds
95	Configuration data is illegal when power supply drop	B	Red	On 0.5 seconds and Off 0.5 seconds
96	Function code illegal	B	Red	On 0.5 seconds and Off 0.5 seconds
97	Operand illegal	B	Red	On 0.5 seconds and Off 0.5 seconds
98	Number of instructions for the same sort out of scope	B	Red	On 0.5 seconds and Off 0.5 seconds
99	No end instruction	B	Red	On 0.5 seconds and Off 0.5 seconds
100	Access 1# expansion module I/O fails	C	Yellow	On 0.8 seconds and Off 0.2 seconds
101	Access 2# expansion module I/O fails	C	Yellow	On 0.8 seconds and Off 0.2 seconds
102	Access 3# expansion module I/O fails	C	Yellow	On 0.8 seconds and Off 0.2 seconds
103	Access 4# expansion module I/O fails	C	Yellow	On 0.8 seconds and Off 0.2 seconds
104	Access 5# expansion module I/O fails	C	Yellow	On 0.8 seconds and Off 0.2 seconds
105	Access 6# expansion module I/O fails	C	Yellow	On 0.8 seconds and Off 0.2 seconds
106	Access 7# expansion module I/O fails	C	Yellow	On 0.8 seconds and Off 0.2 seconds
107	Access 8# expansion module I/O fails	C	Yellow	On 0.8 seconds and Off 0.2 seconds
108	Access 9# expansion module I/O fails	C	Yellow	On 0.8 seconds and Off 0.2 seconds
109	Access 10# expansion module I/O fails	C	Yellow	On 0.8 seconds and Off 0.2 seconds
110	Access 11# expansion module I/O fails	C	Yellow	On 0.8 seconds and Off 0.2 seconds
111	Access 12# expansion module I/O fails	C	Yellow	On 0.8 seconds and Off 0.2 seconds
112	Access 13# expansion module I/O fails	C	Yellow	On 0.8 seconds and Off 0.2 seconds
113	Access 14# expansion module I/O fails	C	Yellow	On 0.8 seconds and Off 0.2 seconds
114	Access 15# expansion module I/O fails	C	Yellow	On 0.8 seconds and Off 0.2 seconds
131	RTC battery failure	C	Yellow	On 0.8 seconds and Off 0.2 seconds
132	expansion module power supply not normal	C	Yellow	On 0.8 seconds and Off 0.2 seconds
133	Storage program and running program inconsistent	C	Yellow	On 0.8 seconds and Off 0.2 seconds
140	Hardware configuration incompatible	D	Yellow	On 0.2 seconds and Off 0.8 seconds
141	Scan timeout watchdog operate	B	Red	On 0.5 seconds and Off 0.5 seconds
142	Have locked datas	D	Yellow	On 0.2 seconds and Off 0.8 seconds
143	Current running step tasks is above upper limit	D	Yellow	On 0.2 seconds and Off 0.8 seconds

Communication Address Code Table

Haiwell PLC Bit Component

Equivalently Modbus address type 0, 1, support Modbus function code 1, 2, 5, 15)

Component	Name	Component Range	Read/ Write	Modbus Communication Address Code		Declare
				Hexadecimal	Decimal	
X	External input	X0~X1023	R	0x0000~0x03FF	0~1023	
Y	External output	Y0~Y1023	R/W	0x0600~0x09FF	1536~2559	
M	Auxiliary relay	M0~M12287	R/W	0x0C00~0x3BFF	3072~15359	
T	Timer(output coil)	T0~T1023	R/W	0x3C00~0x3FFF	15360~16383	
C	Counter(output coil)	C0~C255	R/W	0x4000~0x40FF	16384~16639	
SM	System status bit	SM0~SM215	all be read, some be wrote	0x4200~0x42D7	16896~17111	
S	Step relay	S0~S2047	R/W	0x7000~0x77FF	28672~30719	

Haiwell PLC Register Component

(Equivalently Modbus address type 3, 4, support Modbus function code 3, 4, 6, 16)

Component	Name	Component Range	Read/ Write	Modbus Communication Address Code		Declare
				Hexadecimal	Decimal	
CR	expansion module parameter	CR0~CR255	All can be read, some can be wrote	0x00~0xFF	0~255	Use Modbus protocol to access expansion module
AI	Analog input register	AI0~AI255	R	0x0000~0x00FF	0~255	
AQ	Analog output register	AQ0~AQ255	R/W	0x0100~0x01FF	256~511	
V	Internal data register	V0~V14847	R/W	0x0200~0x3BFF	512~15359	
TV	Timer(current value)	TV0~TV1023	R/W	0x3C00~0x3FFF	15360~16383	
CV	Counter(current value)	CV0~CV255	R/W	0x4000~0x40FF	16384~16639	16 bit register, among CV48~CV79 32 bit register
SV	System special register	SV0~SV900	All can be read, some can be wrote	0x4400~0x4784	17408~18308	

Declare:

- Haiwell PLC use the stand Modbus protocol (support RTU and ASCII mode),can communicate to HMI and configuration soft which support Modbus protocol
- Haiwell PLC's Modbus addressing number from 0, Some HMI or configuration soft from 1,if HMI or configuration soft Modbus addressing from 0 then communicate direct, e.g. M0 is 0x3072,V0 is 4x0512. if HMI or configuration soft Modbus addressing from 1 then the address must add 1,e.g.M0 is 0x3073[3072+1],V0 is 4x0513[512+1].The first place address is the Modbus protocol component type(0/1 is bit relay ,3/4 is word register , 0/4 can read and write,1/3 read only)other places are the component address.

Correspondence Address Setting

Method 1:

modify address by code switch. The 4-bit code switch is used to set PLC's address, as shown in the figure on the right side. The black rectangle indicates the position of each code switch. When the switch was toggled to ON, the bit was set to 1, bit will be set to 0 when the corresponding switch was toggled to OFF. The 4-bit code switch's state indicates PLC's address by the following rule: the "1" switch represents the first bit (b0), the "4" switch represents the fourth bit (b3). Therefore the 4-bit code switch is able to represents binary number range from 0000 to 1111, PLC's address will be the decimal number converted from the binary number set by the code switch.



Method 2:

modify address through programming software interface. Select "PLC" option in the menu bar, then select "Setup PLC Parameters" option from the follow-up options, checked "Use PLC Soft Address".

Method 3:

Haiwell PLC with Ethernet port, the default IP address is : 192.168.1.111. Hardware DIP dial switch address range: 1-15, the default address is 1. If you need to set a bigger address range, you can set on the software after connection with PLC, it can be set on the PLC parameter option in the software menu by checking on the "soft address" with the range of 1-254(the soft address is prior to the hardware dial address).



XIAMEN HAIWELL TECHNOLOGY CO., LTD.

Headquarters: 13-14/F, C03 Building, Phase III Software Park, Jimei District, Xiamen, Fujian, China

Factory: 4F, No. 336-2, Anbian Nan Road, Torch High-tech Zone (Xiang 'an) Industrial Zone, Xiang 'an District,
Xiamen, Fujian, China

Technical support: +86-592-3278716 Sales: +86-4000-360-362

E-Mail: service@haiwell.com

Website: www.haiwell.com